

FLAT CABLE SUPPRESSION CORE(FP)

Ordering code

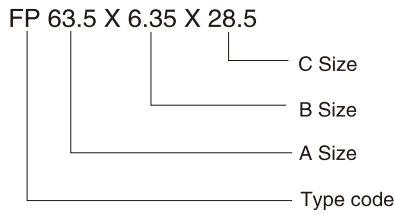

CONFIGURATIONS(mm)

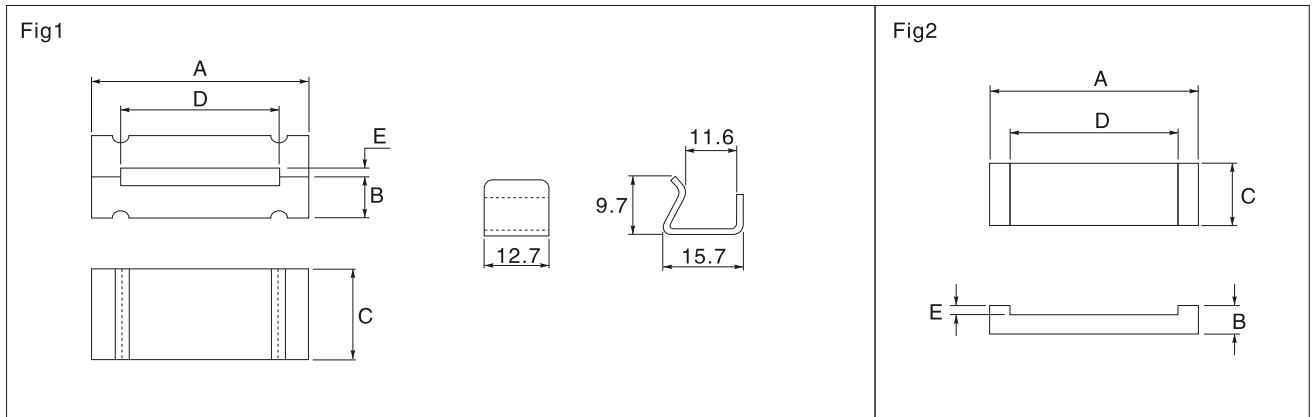

DIMENSION OF MAIN PRODUCTIONS & IMPEDANCE@25°C

Part No.	Fig.	A	B	C	D	E	IMPEDANCE	
							25MHz(Ω)	100MHz(Ω)
FP 38X6.35X10	1	38.0±1	6.35±0.25	10.0±0.4	26.6±0.7	0.8±0.2	45	107
FP 38X6.35X25.4	1	38.0±1	6.35±0.25	25.4±0.7	26.6±0.7	0.8±0.2	105	175
FP 45X6X10	1	45.0±1	6.0±0.25	10.0±0.4	34.4±0.7	0.8±0.2	43	110
FP 45X6.35X10	1	45.0±1	6.35±0.25	10.0±0.4	34.4±0.7	0.8±0.2	41	98
FP 45X6.35X28.5	1	45.0±1	6.35±0.25	28.5±0.7	34.4±0.7	0.8±0.2	102	189
FP55.1X6.35X28.5	1	55.1±1.2	6.35±0.25	28.5±0.7	43.7±1	0.8±0.2	80	181
FP 63.5X6.35X13	1	63.5±1.2	6.35±0.25	13.0±0.4	52.0±1	0.8±0.2	45	114
FP63.5X6.35X15	1	63.5±1.2	6.35±0.25	15.0±0.4	52.0±1	0.8±0.2	50	124
FP63.5X6.35X28.5	1	63.5±1.2	6.35±0.25	28.5±0.7	52.0±1	0.8±0.2	77	172
FP 76.2X6.35X28.5	1	76.2±1.5	6.35±0.25	28.5±0.7	65.3±1.3	0.85±0.2	70	200
FP 16.5X2X10.25	2	16.5±0.3	2.0±0.2	10.25±0.4	12.5±0.3	0.6±0.2	31	75
FP 32X2.1X12	2	32.0±0.5	2.1±0.2	12.0±0.5	27.0±0.7	0.4±0.2	30	87
FP 40X3.25X12	2	40.0±1	3.25±0.25	12.0±0.5	35.0±0.7	0.55±0.2	20	60
FP 49.6X3.25X12	2	49.6±1	3.25±0.25	12.0±0.5	44.0±0.8	0.55±0.2	23	70

Remarks: Other sizes are available upon request if your needs not listed in the catalog

ROD CORES(R)

Ordering code

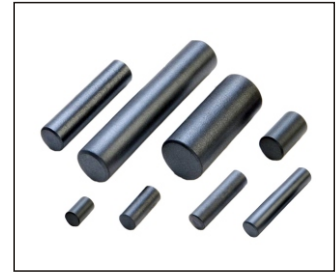
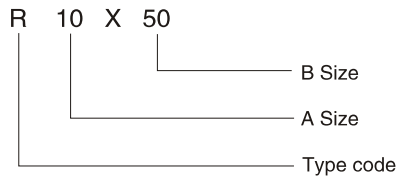

CONFIGURATIONS(mm)

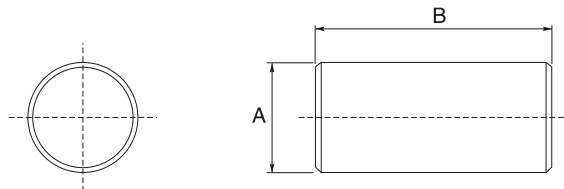

DIMENSION OF MAIN PRODUCTIONS & IMPEDANCE@25°C

Part No.	A	B	Part No.	A	B
R0.76X4.83	0.76±0.5	4.82±0.25	R5.85X30	5.85±0.2	30.0±1
R1.2X5.9	1.2±0.1	5.9±0.3	R6X10	6.0±0.2	10.0±0.3
R1.9X5	1.9±0.1	5.0±0.2	R6X15	6.0±0.2	15.0±0.5
R1.65X8	1.65±0.1	8.0±0.3	R6X20	6.0±0.2	20.0±0.6
R1.65X14	1.65±0.1	14.0±0.6	R6X25	6.0±0.2	25.0±0.6
R1.7X6	1.7±0.1	6.0±0.3	R6X30	6.0±0.2	30.0±0.8
R1.75X18.5	1.75±0.1	18.5±0.6	R6.25X30	6.25±0.2	30.0±0.8
R1.9X4.7	1.9±0.1	4.7±0.2	R6.35X25.4	6.35±0.2	25.4±0.6
R2X10	2.0±0.1	10.0±0.3	R6.35X30	6.35±0.2	30.0±0.8
R2X14	2.0±0.1	14.0±0.5	R6.5X15	6.5±0.2	15.0±0.4
R2.3X20	2.3±0.1	20.0±0.6	R6.5X20	6.5±0.2	20.0±0.5
R2.5X20	2.5±0.1	20.0±0.6	R6X38	6.0±0.2	38.0±1
R2.8X11	2.8±0.1	11.0±0.3	R6.2X22.5	6.2±0.2	22.5±0.5
R3X10	3.0±0.1	10.0±0.3	R6.2X37.5	6.2±0.2	37.5±1
R3X20	3.0±0.1	20.0±0.6	R7.3X30	7.3±0.2	30.0±1
R3X36.5	3.0±0.1	36.5±1	R7X25	7.0±0.2	25.0±0.5
R3.3X20	3.3±0.1	20.0±0.6	R8X20	8.0±0.2	20.0±0.5
R3.5X25	3.5±0.15	25.0±0.8	R8X25	8.0±0.2	25.0±0.5
R4X15	4.0±0.15	15.0±0.4	R8X30	8.0±0.2	30.0±0.8
R4X20	4.0±0.15	20.0±0.5	R8X32	8.0±0.2	32.0±0.8
R4X25	4.0±0.15	25.0±0.8	R9.5X19	9.5±0.2	19.0±0.5
R5X10	5.0±0.15	10.0±0.3	R9.5X31.75	9.5±0.2	131.75±0.8
R5X12.5	5.0±0.15	12.5±0.4	R10X20	10.0±0.3	20.0±0.6
R5X15	5.0±0.15	15.0±0.5	R10X30	10.0±0.3	30.0±0.8
R5X20	5.0±0.15	20.0±0.5	R10X50	10.0±0.3	50.0±1.5
R5X25	5.0±0.15	25.0±0.5	R12X40	12.0±0.3	40.0±1
R5X30	5.0±0.15	30.0±0.8			
R5.5X21	5.5±0.2	21.0±0.5			

Remarks: Other sizes are available upon request if your needs not listed in the catalog

THROUGH-HOLE AXIAL WIDE BAND CHOKES R6H SERIES (01,02,03,04,05,06,07)

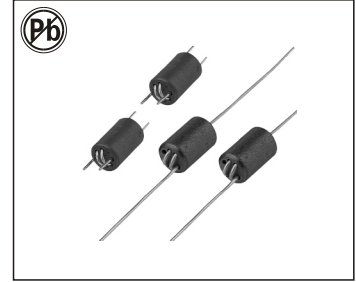

FEATURES:

- Regged construction
- Counter measures for FCC,VDE
- CSA,CE,VCC1
- EMI/RFI suppression
- High reliability
- Long term stability

COMMON APPLICATIONS:

- Telecommunication Equipment
- Wireless Communications Equipment
- Computer Products
- General Electronic Applications where EMI/RFI suppression is required

ELECTRICAL CHARACTERISTICS:

Part Number	Number of Turns	Impedance @25MHz	Impedance @100MHz
R6H-01	1.5	300	500
R6H-02	2.0	400	600
R6H-03	2.5	600	800
R6H-04	2.5	500	600
R6H-05	3.0	800	900
R6H-06	3.0	700	600
R6H-07	1.5 x 2	300	500

TECHNICAL INFORMATION: PHYSICAL CHARACTERISTICS:

CORE	1.5Ts	2Ts	2.5Ts	3Ts	2 x 1.5Ts

Ferrite core TYPE	A	B	C	D
R6H 6 x 10	6.0 ± 0.25	10.0 ± 0.30	0.75 ± 0.15	3.5 ref

• Testing:(Equivalent acceptable)
HP4191A Impedance Analyzer

BEAD CORES,RADIAL TAPPING & BULK TYPE(RH)

Ordering code

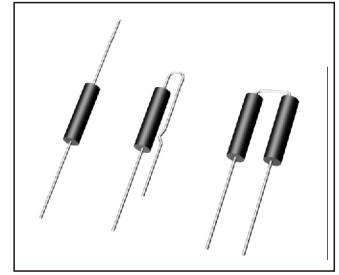
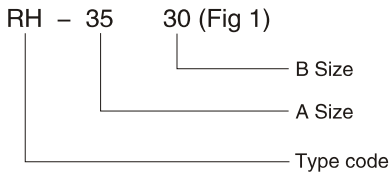

CONFIGURATIONS(mm)

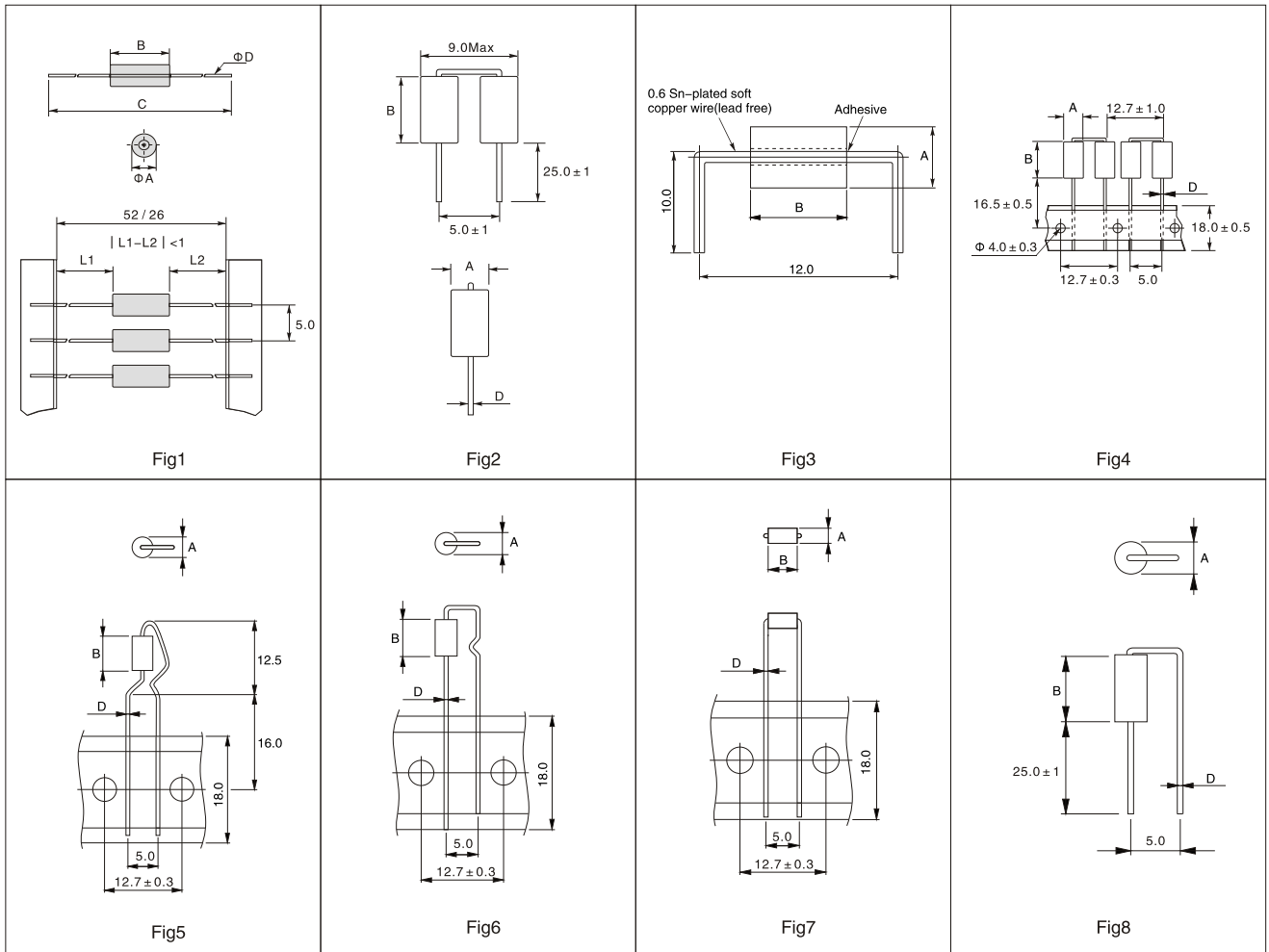

DIMENSION OF MAIN PRODUCTIONS & IMPEDANCE@25°C

Part Number	A	B	C	D	Impedance @25MHz (Ω)Min	Impedance @100MHz (Ω)Min
RH-3530	3.5 ± 0.2	3.0 ± 0.3	62 ± 2.0	0.6	25	40
RH-3545	3.5 ± 0.2	4.5 ± 0.3	62 ± 2.0	0.6	30	60
RH-3547	3.5 ± 0.2	4.7 ± 0.3	62 ± 2.0	0.6	35	60
RH-3560	3.5 ± 0.2	6.0 ± 0.3	62 ± 2.0	0.6	50	75
RH-3575	3.5 ± 0.2	7.5 ± 0.3	62 ± 2.0	0.6	60	90
RH-3580	3.5 ± 0.2	8.0 ± 0.3	62 ± 2.0	0.6	60	100
RH-3590	3.5 ± 0.2	9.0 ± 0.3	62 ± 2.0	0.6	80	120
RH-3512	3.5 ± 0.2	12 ± 0.3	62 ± 2.0	0.6	30	130
RH-3514	3.5 ± 0.2	14 ± 0.3	62 ± 2.0	0.6	50	150

Remarks: Other sizes are available upon request if your needs not listed in the catalog

BEAD CORE(RH)

Ordering code

FP 63.5 X 6.35 X 28.5

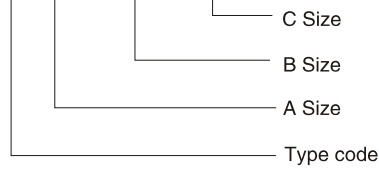

CONFIGURATIONS(mm)

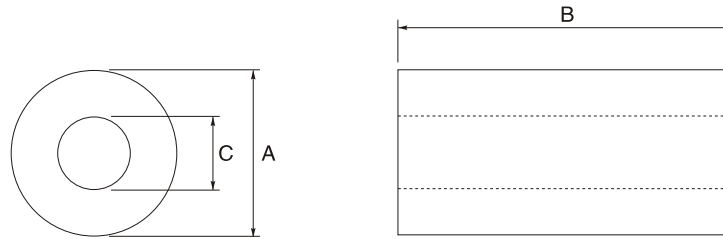

DIMENSION OF MAIN PRODUCTIONS & IMPEDANCE@25°C

Part No.	A	B	C	IMPEDANCE	
				25MHz(Ω)	100MHz(Ω)
RH1.6X5X0.8	1.6 \pm 0.15	5.0 \pm 0.3	0.8 \pm 0.1	/	33
RH2.45X2.5X1.3	2.45 \pm 0.15	2.5 \pm 0.2	1.3 \pm 0.1	/	/
RH2.5X3X0.8	2.5 \pm 0.15	3.0 \pm 0.2	0.8 \pm 0.15	20	30
RH2.5X3X1	2.5 \pm 0.15	2.5 \pm 0.15	1.0 \pm 0.15	10	30
RH2.85X3.75X1.65	2.85 \pm 0.15	3.75 \pm 0.2	1.65 \pm 0.15	18	50
RH3X3X0.8	3.0 \pm 0.15	3.0 \pm 0.2	0.8 \pm 0.15	/	/
RH3X3X1	3.0 \pm 0.15	3.0 \pm 0.2	1.0 \pm 0.15	/	/
RH3X3.5X1.2	3.0 \pm 0.3	3.5 \pm 0.3	1.2 \pm 0.2	15	45
RH3.5X14X0.8	3.5 \pm 0.15	14.0 \pm 0.4	0.8 \pm 0.1	/	185
RH3.5X6X0.9	3.5 \pm 0.15	6.0 \pm 0.3	0.9 \pm 0.1	40	70
RH3.5X14X1	3.5 \pm 0.15	14.0 \pm 0.4	1.0 \pm 0.1	/	180
RH3.5X3X1.3	3.5 \pm 0.15	3.0 \pm 0.2	1.3 \pm 0.1	10	20
RH3.5X5X1.5	3.5 \pm 0.15	5.0 \pm 0.3	1.5 \pm 0.15	20	45
RH3.5X12X1.5	3.5 \pm 0.2	12.0 \pm 0.4	1.5 \pm 0.1	45	75
RH3.5X5.9X1.8	3.5 \pm 0.15	5.9 \pm 0.3	1.8 \pm 0.15	/	/
RH3.5X4X2	3.5 \pm 0.2	4.0 \pm 0.3	2.0 \pm 0.2	10	25
RH3.5X6X2	3.5 \pm 0.2	6.0 \pm 0.3	2.0 \pm 0.2	15	30
RH3.8X8.3X0.8	3.8 \pm 0.15	8.3 \pm 0.3	0.8 \pm 0.1	/	100
RH3.9X5X1.3	3.9 \pm 0.15	5.0 \pm 0.3	1.3 \pm 0.1	/	/
RH4X15X0.8	4.0 \pm 0.15	15.0 \pm 0.4	0.8 \pm 0.1	/	/
RH4X5X1.5	4.0 \pm 0.2	5.0 \pm 0.3	1.5 \pm 0.15	20	35
RH4X15X2	4.0 \pm 0.2	15.0 \pm 0.4	2.0 \pm 0.15	50	80
RH4X25X2	4.0 \pm 0.2	25.0 \pm 0.3	2.0 \pm 0.15	90	120
RH4X6X2.2	4.0 \pm 0.2	6.0 \pm 0.3	2.2 \pm 0.15	20	40
RH4X25X2.2	4.0 \pm 0.2	25.0 \pm 0.6	2.2 \pm 0.15	90	120

BEAD CORE(RH)**DIMENSION OF MAIN PRODUCTIONS & IMPEDANCE@25°C**

Part No.	A	B	C	IMPEDANCE	
				25MHz(Ω)	100MHz(Ω)
RH4.1X6X0.8	4.1±0.2	6.0±0.3	0.8±0.1	90	/
RH4.1X6X2	4.1±0.2	6.0±0.3	2.0±0.15	20	30
RH4.2X15X2	4.2±0.2	15.0±0.4	2.0±0.15	45	90
RH4.5X3.5X1.5	4.5±0.2	3.5±0.25	1.5±0.15	15	30
RH4.5X7X1.5	4.5±0.2	7.0±0.3	1.5±0.1	40	80
RH4.5X7X2.5	4.5±0.2	7.0±0.3	2.5±0.15	35	65
RH4.5X6X3	4.5±0.2	6.0±0.3	3.0±0.2	/	/
RH4.7X25X2.75	4.7±0.2	25.0±0.6	2.75±0.15	/	/
RH4.8X3.8X2.5	4.8±0.4	3.8±0.3	2.5±0.2	15	50
RH4.9X36X2	4.9±0.2	36±0.8	2.0±0.15	140	200
RH5X10X1	5.0±0.2	10.0±0.4	1.0±0.15	35	55
RH5X18X2.15	5.0±0.2	18.0±0.5	2.15±0.15	80	120
RH5.08X10X2.29	5.08±0.2	10.0±0.4	2.29±0.15	40	65
RH6X25X2	6.0±0.2	25.0±0.6	2.0±0.15	135	200
RH6X30X2.2	6.0±0.2	30.0±0.3	2.2±0.15	/	/
RH6X10X3.2	6.0±0.2	10.0±0.4	3.2±0.2	/	50
RH6X15X3	6.0±0.2	15.0±0.4	3.0±0.2	/	/
RH6.35X25.4X2.95	6.35±0.2	25.4±0.6	2.95±0.15	108	200
RH6.35X12.7X3.2	6.35±0.2	12.7±0.4	3.2±0.2	55	102
RH6.4X10X3.2	6.4±0.2	10.0±0.4	3.2±0.2	/	50
RH6.5X10X4	6.5±0.2	10.0±0.4	4.0±0.2	20	40
RH6.5X10X4.3	6.5±0.25	10.0±0.4	4.3±0.2	20	45
RH6.5X10X4.5	6.5±0.2	10.0±0.4	4.5±0.2	15	35
RH6.75X14.22X4	6.75±0.2	14.22±0.4	4.0±0.2	/	/
RH7.52X7.54X2.39	7.52±0.2	7.54±0.3	2.39±0.1	30	60
RH7.65X4.78X3.18	7.65±0.3	4.78±0.2	3.18±0.2	20	45
RH7.8X13X4	7.8±0.2	13.0±0.4	4.0±0.2	45	80
RH7.8X12.5X5	7.8±0.2	12.5±0.4	5.0±0.25	30	60
RH8X25X3.6	8.0±0.3	25.0±0.6	3.6±0.2	65	115
RH8X15X5.3	8.0±0.2	15.0±0.4	5.3±0.25	40	80
RH8X5X6	8.0±0.3	5.0±0.2	6.0±0.2	10	45
RH8.3X9.75X3.6	8.3±0.2	9.75±0.3	3.6±0.2	/	/
RH8.7X15.7X6.3	8.7±0.2	15.7±0.4	6.3±0.3	/	80
RH9X16X5	9.0±0.3	16.0±0.4	5.0±0.25	50	80
RH9.05X16X5	9.05±0.3	16.0±0.4	4.7±0.2	60	110
RH9.3X4.5X9.5	9.3±0.3	9.5±0.3	4.5±0.2	/	/
RH9.3X15.7X6.35	9.3±0.3	15.7±0.4	6.35±0.2	/	/
RH9.5X10.2X3.05	9.5±0.5	10.2±0.4	3.05±0.2	50	90
RH9.5X25X4.7	9.5±0.4	25.0±0.6	4.7±0.2	73	135
RH9.5X19.5X5.5	9.5±0.2	19.5±0.6	5.5±0.3	50	100
RH9.5X19.05X4.75	9.5±0.3	19.05±0.4	4.75±0.2	60	100

BEAD CORE(RH)

DIMENSION OF MAIN PRODUCTIONS & IMPEDANCE@25°C

Part No.	A	B	C	IMPEDANCE	
				25MHz(Ω)	100MHz(Ω)
RH9.5X25.4X4.75	9.5±0.3	25.4±0.6	4.75±0.2	75	135
RH9.5X14.5X4.8	9.5±0.3	14.5±0.4	4.8±0.2	53	75
RH9.5X14.5X5	9.5±0.3	14.5±0.4	5.0±0.25	50	100
RH9.5X9.5X5.2	9.5±0.3	9.5±0.4	5.2±0.25	35	65
RH9.65X10.4X5.02	9.65±0.3	10.4±0.4	5.02±0.25	30	60
RH9.7X10.2X3.8	9.7±0.3	10.2±0.4	3.8±0.2	60	100
RH9.8X11.5X1	9.8±0.3	11.5±0.3	1.0±0.15	120	200
RH9.8X15.7X6.3	9.8±0.3	15.7±0.4	6.3±0.3	45	65
RH9.8X13.5X6.35	9.8±0.3	13.5±0.4	6.35±0.2	30	60
RH10X20X5	10.0±0.3	20.0±0.5	5.0±0.2	70	120
RH10X20X6.35	10.0±0.3	20.0±0.5	6.35±0.2	40	70
RH10X25X5	10.0±0.3	25.0±0.6	5.0±0.25	125	160
RH10X25X5.5	10.0±0.3	25.0±0.6	5.5±0.25	90	160
RH10X14X6	10.0±0.3	14.0±0.4	6.0±0.3	35	75
RH10X6.2X6.15	10.0±0.3	6.2±0.3	6.15±0.3	45	85
RH10X20X6.5	10.0±0.4	20.0±0.6	6.5±0.25	40	90
RH10X10X7	10.0±0.3	10.0±0.4	7.0±0.3	20	40
RH10X7.5X7.3	10.0±0.3	7.5±0.2	7.3±0.2	13	28
RH10.2X20X5.5	10.2±0.4	20.0±0.5	5.5±0.25	65	120
RH10.5X20X6	10.5±0.4	20.0±0.6	6.0±0.3	50	90
RH10.5X20X6.5	10.5±0.3	20.0±0.5	6.5±0.3	40	80
RH11X25X5	11.0±0.3	25.0±0.6	5.0±0.25	115	180
RH11.3X12X5.95	11.3±0.3	12.0±0.4	5.95±0.25	40	70
RH11.5X20X4.9	11.5±0.5	20.0±0.6	4.9±0.25	100	200
RH11.5X25X4.9	11.5±0.3	25.0±0.6	4.9±0.25	85	120
RH11.8X15X5	11.8±0.3	15.0±0.4	5.0±0.3	40	80
RH11.8X15X7.3	11.8±0.3	15.0±0.4	7.3±0.3	40	75
RH11.86X15X7.4	11.86±0.3	15.0±0.4	7.4±0.3	35	75
RH12X19.2X3.7	12.0±0.3	19.2±0.6	3.7±0.2	60	120
RH12X23.5X3.7	12.0±0.3	23.5±0.6	3.7±0.2	95	160
RH12X23X4	12.0±0.3	23.0±0.5	4.0±0.2	160	230
RH12X25X4.5	12.0±0.3	25.0±0.4	4.5±0.2	125	204
RH12X20X5.6	12.0±0.3	20.0±0.5	5.6±0.25	100	200
RH12X25X5.6	12.0±0.4	25.0±0.6	5.6±0.3	80	120
RH12X20X6	12.0±0.3	20.0±0.5	6.0±0.3	60	110
RH12X13X8	12.0±0.3	13.0±0.4	8.0±0.3	35	75
RH12X22.8X8	12.0±0.3	22.8±0.6	8.0±0.25	40	80
RH12X15X8.5	12.0±0.3	15.0±0.4	8.5±0.3	30	50
RH12X20X8.5	12.0±0.3	20.0±0.4	8.5±0.2	30	60
RH12.3X12.7X5	12.3±0.3	12.7±0.4	5.0±0.25	60	120
RH12.7X12.7X7.9	12.7±0.3	12.7±0.4	7.9±0.3	30	60

BEAD CORE(RH)

DIMENSION OF MAIN PRODUCTIONS & IMPEDANCE@25°C

Part No.	A	B	C	IMPEDANCE	
				25MHz(Ω)	100MHz(Ω)
RH13X18X5	13.0±0.3	18.0±0.5	5.0±0.25	50	100
RH13X20X5	13.0±0.3	20.0±0.5	5.0±0.25	90	140
RH13X15X7	13.0±0.3	15.0±0.4	7.0±0.3	75	140
RH13X12.7X7.3	13.0±0.4	12.7±0.4	7.3±0.2	30	60
RH13X25X8.5	13.0±0.3	25.0±0.6	8.5±0.2	40	80
RH14X15X6.8	14.0±0.4	15.0±0.4	6.8±0.3	65	120
RH14X15X7.8	14.0±0.4	15.0±0.4	7.8±0.3	35	70
RH14.2X20X4.5	14.2±0.4	20.0±0.5	4.5±0.3	100	170
RH14.2X28.5X4.5	14.2±0.4	28.5±0.8	4.5±0.3	120	280
RH14.2X28.5X6.35	14.2±0.4	28.5±0.6	6.35±0.6	100	190
RH14.2X36X6.35	14.2±0.4	36.0±0.8	6.35±0.6	150	280
RH14.2X15X6.5	14.2±0.4	15.0±0.4	6.5±0.3	50	90
RH14.2X28.5X7.2	14.2±0.4	28.5±0.6	7.2±0.3	130	210
RH14.2X28.5X7	14.2±0.4	28.5±0.6	7.0±0.3	100	120
RH14.2X12.7X7.2	14.2±0.3	12.7±0.7	7.2±0.3	40	60
RH14.2X23.5X8	14.2±0.4	23.5±0.5	8.0±0.3	56	135
RH14.2X28.5X8	14.2±0.4	28.5±0.6	8.0±0.3	60	150
RH14.2X28.5X9.15	14.2±0.4	28.5±0.6	9.15±0.5	100	170
RH14.2X15X9	14.2±0.4	15.0±0.4	9.0±0.3	50	100
RH14.3X23.3X6.35	14.3±0.4	23.3±0.5	6.35±0.3	100	180
RH14.3X28.5X9.15	14.3±0.4	28.5±0.6	9.15±0.3	75	120
RH14.3X28.5X9	14.3±0.4	28.5±0.6	9.0±0.3	75	120
RH15.7X28.5X10.5	15.7±0.4	28.5±0.6	10.5±0.3	60	100
RH15.7X28.5X7.5	15.7±0.4	28.5±0.6	7.5±0.3	90	180
RH15.7X35X7.3	15.7±0.5	35.0±0.8	7.3±0.4	120	230
RH15.88X28.5X8	15.88±0.5	28.5±0.6	8.0±0.4	100	160
RH16X16X8	16.0±0.4	16.0±0.4	8.0±0.3	55	110
RH16X17X9	16.0±0.4	17.0±0.4	9.0±0.3	50	80
RH16X28X9	16.0±0.4	28.0±0.6	9.0±0.3	80	150
RH16X28X10.5	16.0±0.4	28.0±0.6	10.5±0.3	/	100
RH17.07X25.4X8.76	17.04±0.4	25.4±0.6	8.76±0.3	90	130
RH17.2X28.5X7	17.2±0.4	28.5±0.6	7.0±0.3	140	230
RH17.2X28X7.1	17.2±0.4	28.0±0.8	7.1±0.3	120	180
RH17.5X25.4X7	17.5±0.4	25.4±0.6	7.0±0.3	110	200
RH17.5X12.7X9.5	17.5±0.5	12.7±0.4	9.5±0.3	50	150
RH17.5X28.5X9.5	17.5±0.4	28.5±0.5	9.5±0.3	85	145
RH17.5X35X9.5	17.2±0.4	35.0±0.8	9.5±0.3	120	200
RH17.5X24X10.5	17.2±0.4	24.0±0.6	10.5±0.4	85	130
RH17.5X28.5X10.5	17.5±0.4	28.5±0.6	10.5±0.4	60	120
RH17.5X28.5X10	17.5±0.4	28.5±0.6	10.0±0.4	100	240
RH17.5X28.5X11	17.5±0.4	28.5±0.6	11.0±0.4	80	130

BEAD CORE(RH)

DIMENSION OF MAIN PRODUCTIONS & IMPEDANCE@25°C

Part No.	A	B	C	IMPEDANCE	
				25MHz(Ω)	100MHz(Ω)
RH17.5X28.5X11.5	17.5±0.5	28.5±0.8	11.5±0.4	60	110
RH17.5X28.5X12.8	17.5±0.5	28.5±0.8	12.8±0.4	40	80
RH18X18X10.5	18.0±0.5	18.0±0.5	10.5±0.3	45	90
RH18.2X28.2X9.7	18.2±0.5	28.2±0.6	9.7±0.3	104	192
RH18.4X12X9.6	18.4±0.4	12.0±0.4	9.6±0.3	40	60
RH18.5X28.5X12.6	18.5±0.5	28.5±0.6	12.6±0.5	50	80
RH18.7X28.2X10.2	18.7±0.5	28.2±0.6	10.2±0.4	70	130
RH19X28X6	19.0±0.4	28.0±0.8	6.0±0.3	90	160
RH19X10X10	19.0±0.4	10.0±0.3	10.0±0.3	39	73
RH19X29X13	19.0±0.5	29.0±0.6	13.0±0.4	60	110
RH19.2X28.6X11.6	19.2±0.5	28.6±0.6	11.6±0.4	76	118
RH20X28X10	20.0±0.5	28.0±0.8	10.0±0.3	95	150
RH20.7X28.5X12	20.7±0.6	28.5±0.6	12.0±0.4	85	160
RH20X20X6	20.0±0.5	20.0±0.6	6.0±0.3	130	160
RH21X30X10	21.0±0.5	30.0±0.8	10.0±0.4	100	150
RH22X28X14	22.0±0.6	28.0±0.8	14.0±0.5	60	120
RH25.9X29X12.3	25.9±0.6	29.0±0.6	12.3±0.4	90	180
RH25.9X29X12.7	25.9±0.6	29.0±0.6	12.7±0.3	120	240
RH26X28.5X13	26.0±0.6	28.5±0.6	13.0±0.4	116	180
RH26X28.5X14	26.0±0.6	28.5±0.6	14.0±0.4	90	180
RH26X28.5X12.7	26.0±0.6	28.5±0.6	12.7±0.3	115	170
RH28X28X14	28.0±0.6	28.0±0.6	14.0±0.4	110	180
RH28X28.5X16	28.0±0.6	28.5±0.6	16.0±0.4	110	220
RH28X28.5X18	28.0±0.6	28.5±0.6	18.0±0.4	75	140
RH29X30X10	29.0±0.5	30.0±0.3	10.0±0.3	95	150

Remarks: Other sizes are available upon request if your needs not listed in the catalog

DOUBLE APERTURES CORES(RID)

Ordering code

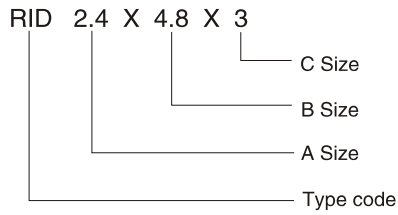

CONFIGURATIONS(mm)

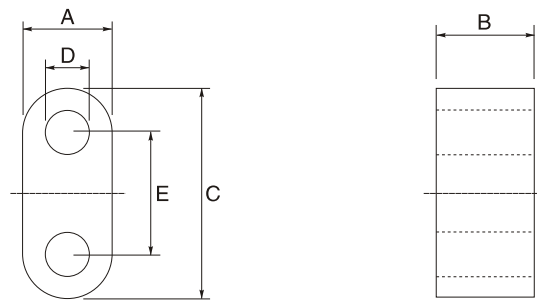

DIMENSION OF MAIN PRODUCTIONS & IMPEDANCE@25°C

Part No.	A	B	C	D	E
RID2.01X3.45X3	2.01±0.15	3.45±0.2	3.0±0.2	1.0±0.15	1.0±0.15
RID2.4X4.8X3	2.4±0.15	4.8±0.2	3.0±0.2	1.2±0.15	1.0±0.15
RID2.5X6X5	2.5±0.2	6.0±0.3	5.0±0.3	1.25±0.15	2.5±0.2
RID3X2X2	3.0±0.2	2.0±0.2	2.0±0.2	1.25±0.15	2.5±0.2
RID3X5X5	3.0±0.2	5.0±0.3	5.0±0.3	1.25±0.15	2.5±0.2
RID3.5X5X6.4	3.5±0.2	5.0±0.3	6.4±0.3	1.8±0.2	3.2±0.2
RID3.5X5X7	3.5±0.2	5.0±0.3	7.0±0.3	1.8±0.2	2.9±0.2
RID4.1X3.2X7	4.1±0.2	3.2±0.2	7.0±0.3	1.8±0.2	2.9±0.2
RID4.1X6.6X7	4.1±0.2	6.6±0.3	7.0±0.3	1.8±0.2	2.9±0.2
RID6.5X4X12	6.5±0.3	4.0±0.2	12.0±0.5	3.8±0.2	5.5±0.3
RID6.5X7X12	6.5±0.3	7.0±0.4	12.0±0.5	3.8±0.2	5.5±0.3
RID7.5X4X13.3	7.5±0.3	4.0±0.2	13.3±0.5	4.1±0.2	6.0±0.3
RID7.5X7X13.3	7.5±0.3	7.0±0.3	13.3±0.5	4.1±0.2	6.0±0.3

Remarks: Other sizes are available upon request if your needs not listed in the catalog

SPLIT SLEEVE CORES(RIS,SSH)

Ordering code

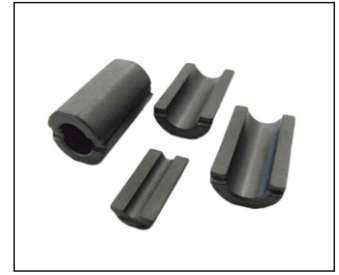
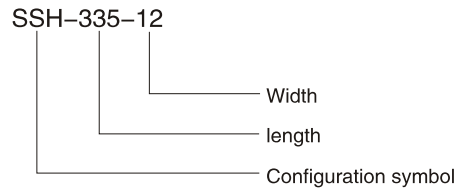
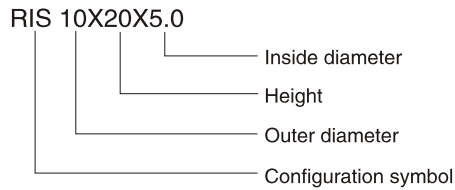

CONFIGURATIONS(mm)

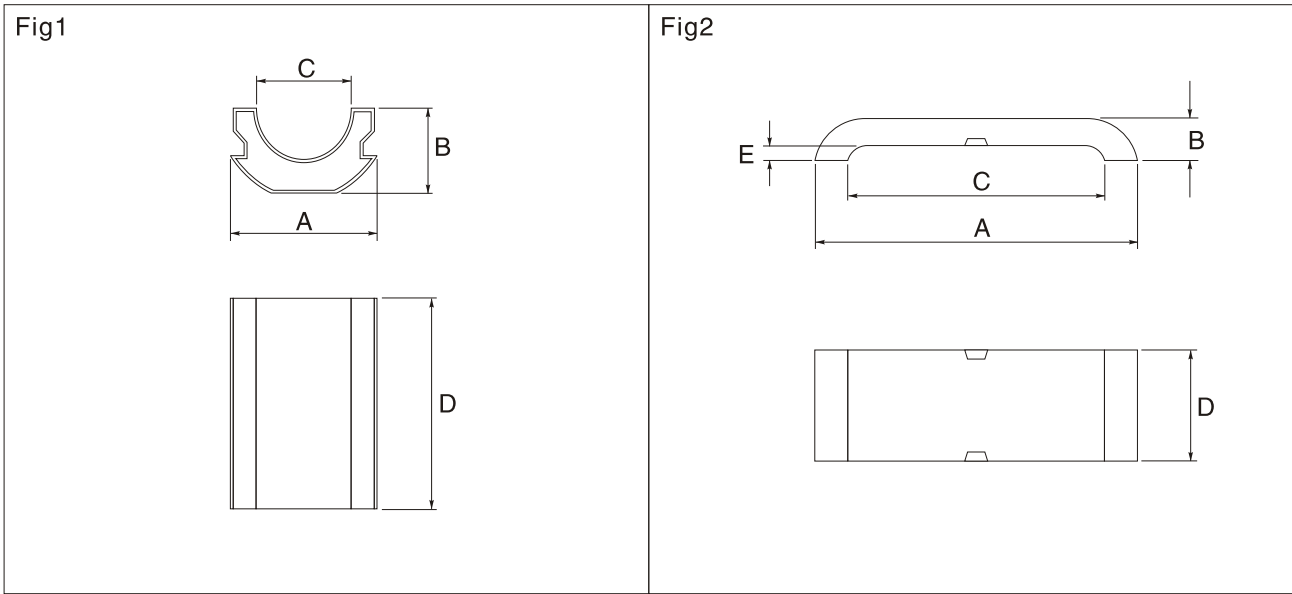

DIMENSION OF MAIN PRODUCTIONS & IMPEDANCE@25°C

Part No.	Fig.	A	B	C	D	E
RIS 10X20X5	1	10±0.3	4.8±0.2	5.0+0.4/-0.2	20±0.5	/
RIS 10X10X20X5H	1	10±0.3	5.15±0.2	5.2±0.3	20±0.5	/
RIS 13.5X13.5X28X6.5H	1	13.5+0.4/-0.3	6.75±0.3	6.5±0.3	28±0.6	/
RIS 14X28X7	1	14±0.4	7±0.3	7±0.3	28±0.6	/
RIS 16X28X9	1	16±0.4	8±0.3	9±0.4	28±0.6	/
RIS 16X16X28X9H	1	16±0.4	8±0.3	9±0.4	28±0.6	/
RIS 18X28X10	1	18±0.4	9±0.3	10±0.4	28±0.6	/
RIS 22X28X11	1	22±0.4	11±0.3	11±0.4	28±0.6	/
RIS 25X28X14	1	25±0.5	12.5±0.3	14±0.4	28±0.8	/
SSH-335-12	2	33.5±1	3.45±0.2	27±0.8	12±0.4	0.4+0.4/-0.1
SSH-335-20	2	33.5±1	3.45±0.2	27±0.8	20±0.5	0.8+0.4/-0.1
SSH-40-12	2	40±1	3.45±0.2	35±0.8	12±0.4	0.6+0.4/-0.1
SSH-45-12	2	45.2±1.2	3.45±0.2	40±0.8	12±0.4	0.6+0.4/-0.1

Remarks:Other sizes are available upon request if your needs not listed in the catalog

DOUBLE TUBE CORES(RU、FU)

Ordering code

RU 24X14X11.5

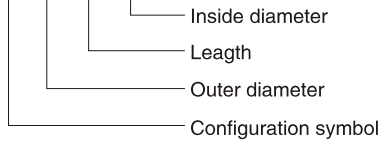

FU 32.5 X 7 X 29 X16 -1.5

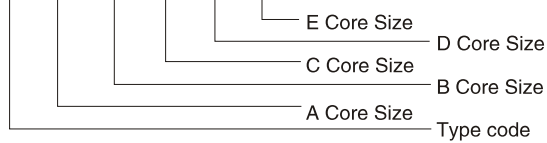

CONFIGURATIONS(mm)

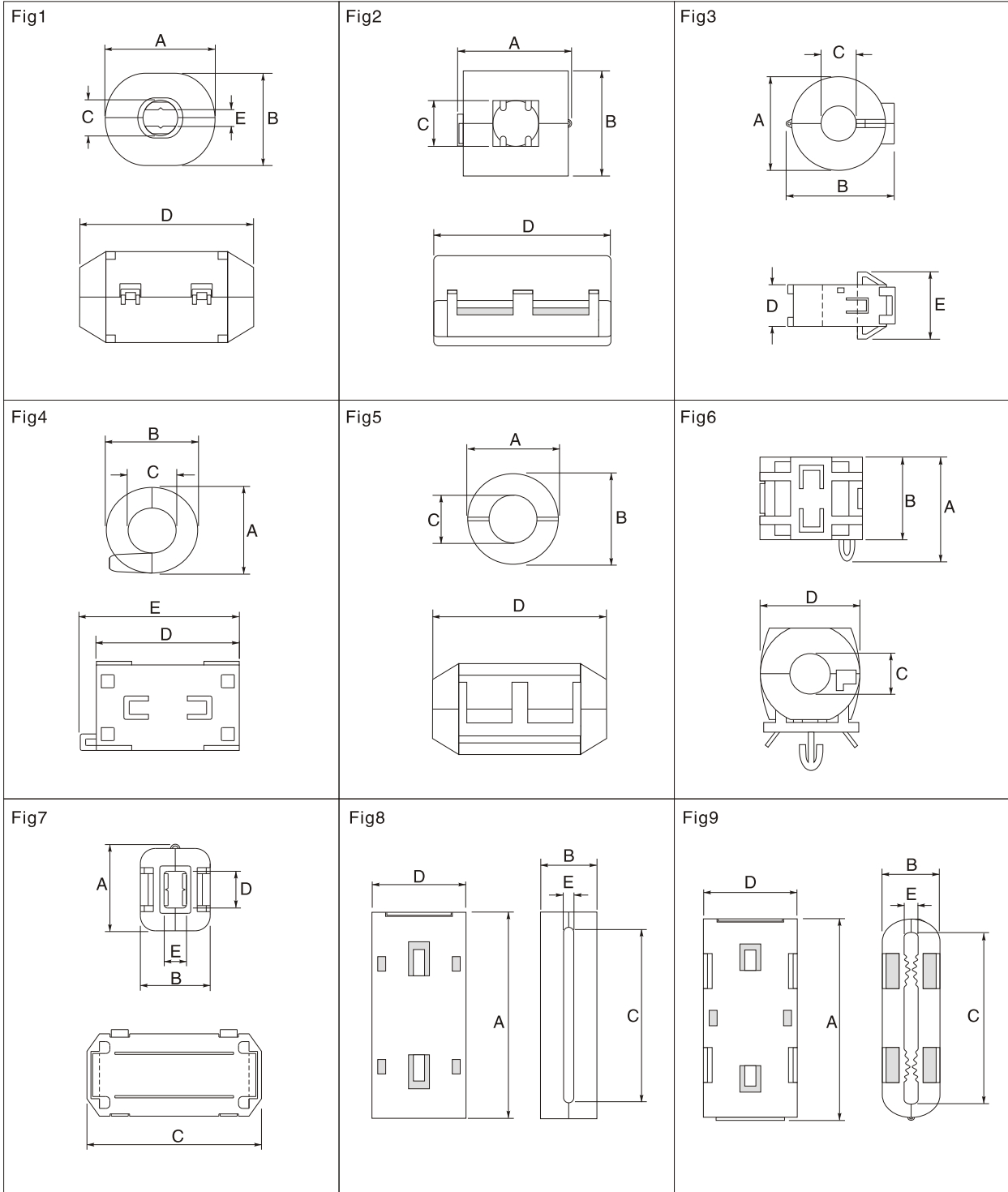

RU TYPE

DIMENSION OF MAIN PRODUCTIONS & IMPEDANCE@25°C

Part No.	Fig.	A	B	C	D	E	IMPEDANCE	
							25MHz(Ω)	100MHz(Ω)
RU35	1	13±1	11.5±1	3.5±0.5	25.2±1	2.5Ref	60	120
RU35B	1	13±1	11.5±1	5±0.5	25.2±1	2.5Ref	45	120
RU36B	1	12±1	11±1	3.6±0.5	21.5±1	2.5Ref	50	100
RU40B	5	15±1	15±1	4±0.5	25.2±1	/	55	95
RU40F	7	19±1	14±1	35±0.5	7.5±1	4±1	90	180
RU50B	5	16.5±1	16.5±1	5.2±0.5	29.5±1	/	60	120
RU55B	5	16.5±1	16.5±1	5.5±0.5	29.5±1	/	60	120
RU70A	4	15.4±1	14.0±1	7±0.5	17.7±1	22±1	35	60
RU70B	1	17±1	15±1	7±0.5	30±1	2.5±1	50	110
RU80B	1	19.5±1	18±1	8±0.5	35±1	5.5±1	80	160
RU90B	1	19.5±1	18±1	9±0.5	35±1	5.5±1	60	130
RU90A	4	20±1	19.5±1	9±0.5	31±1	35.5±1	60	130
RU110A	4	20.5±1	21±1	11±0.5	32±1	36±1	60	110
RU1330A	4	31.5±1	30.5±1	13±0.5	34±1	39.5±1	80	130
RU1330B	1	23.5±1	22.5±1	13±0.5	36±1	8.5±1	70	120
RU7530B	5	21±1	21±1	7.5±0.5	39±1	/	90	150
RU0929A	4	31.5±1	30.5±1	9±0.5	34±1	39.5±1	80	130
RU0933B	5	22.5±1	22.5±1	9.5±0.5	42±1	/	105	190
RU50F	2	15±1	14±1	5.2±0.5	23±1	/	70	120
RU65F	2	20.5±1	20±1	6.5±0.5	33±1	/	120	200
RU100F	2	25.5±1	23.5±1	10±0.5	33±1	/	80	130
RU130F	2	31.5±1	30±1	13±0.5	33±1	/	105	170
RU190F	2	29.3±1	28.6±1	19.8±1	31.8±1	/	40	95
RU16X14X9	6	21±1	17±1	9±1	20±1	/	20	60
RU16X16X8	3	19.5±1	23±1	8.1±0.5	20±1	26±1	50	110
RU16X13X8	3	19.5±1	23±1	8.1±0.5	17±1	23±1	42	85
RU20X10X10	3	24.5±1	28.5±1	10.2±0.5	13.5±1	20±1	35	75
RU24X14X11	3	28±1	32±1	11.5±0.5	18±1	24±1	50	100
RU25X12X15	3	29±1	33±1	15±0.5	15.5±1	21.5±1	30	70

Remarks:Other sizes are available upon request if your needs not listed in the catalog

FU TYPE

Part No.	Fig.	A	B	C	D	E	IMPEDANCE	
							25MHz(Ω)	100MHz(Ω)
FU32.5X7X29X16-1.5	8	36.2 ±0.5	10.0±0.5	28.0 ±0.5	19.0 ±0.5	1.5 ±0.3	20	65
FU33.5X6.8X28X12-1.8	9	37.5±0.5	10.3±0.5	28.0±0.5	15.2±0.5	1.8 ±0.3	25	105
FU35X10X28X15-1.6	9	39.5±0.5	13.0±0.5	28.0 ±0.8	18.5±0.5	1.6 ±0.3	35	160
FU51.5X10X44X15-1.6	9	56.0±0.8	13.5±0.5	44.0 ±0.7	19.0±0.5	1.6 ±0.3	32	145

Remarks:Other sizes are available upon request if your needs not listed in the catalog

COILFORM(SLUG CORE WITH LEADS) (RWW)

Ordering code

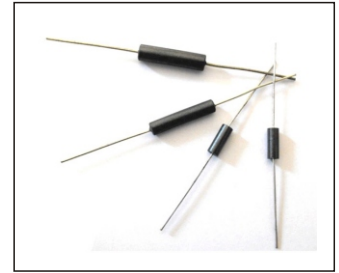
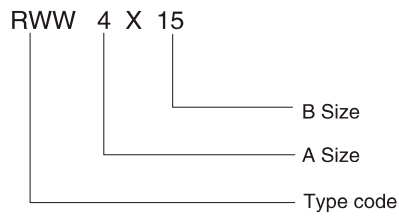

CONFIGURATIONS(mm)

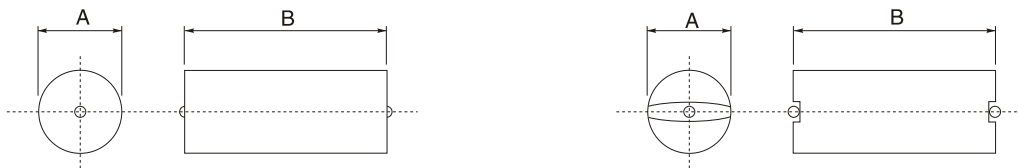



DIMENSION OF MAIN PRODUCTIONS & IMPEDANCE@25°C

Part No.	A	B
RWW1.6X2.0	1.6±0.1	2.0±0.3
RWW2.3X4	2.3±0.1	4.0±0.3
RWW2.8X10	2.8±0.1	10.0±0.3
RWW3X6.0	3.0±0.15	6.0±0.3
RWW3X10	3.0±0.15	10.0±0.3
RWW3.5X10	3.5±0.15	10.0±0.3
RWW4X10	4.0±0.15	10.00±0.3
RWW4X15	4.0±0.15	15.0±0.4
RWW5X15	5.0±0.2	15.0±0.5
RWW5X19.5	5.0±0.2	19.5±0.6
RWW6X20	6.0±0.2	20.0±0.6
RWW6X25	6.0±0.2	25.0±0.8
RWW6X30	6.0±0.2	30.0±0.8
RWW6.35X31.75	6.35±0.2	31.75±1
RWW8X30	8.0±0.3	30.0±0.8

Remarks: Other sizes are available upon request if your needs not listed in the catalog

HIGH CURRENT FERRITE BEADS FOR EMI SUPPRESSION (SMB SERIES)

Type

Type	 SMB403025-45	Type	 SMB853025-75	Type	 SMB564725-25
Z@25MHz	30 Ω Min	Z@25MHz	50 Ω Min	Z@25MHz	15 Ω Min
Z@100MHz	49 Ω Min	Z@100MHz	76 Ω Min	Z@100MHz	25 Ω Min
Rated current	9A max.	Rated current	5A max.	Rated current	15A max.

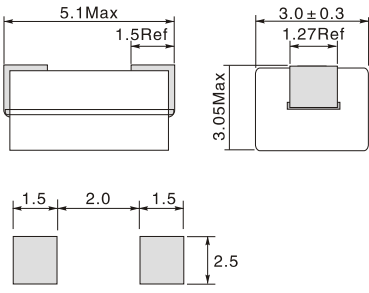
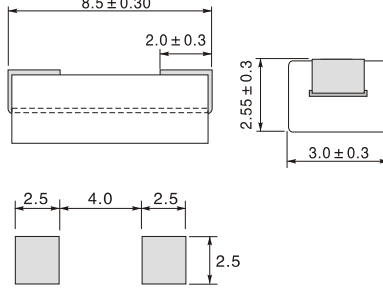
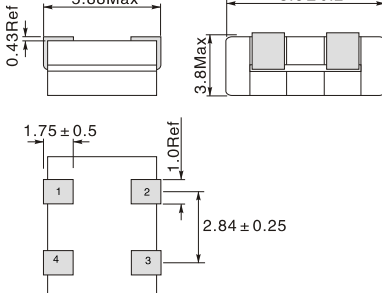
		
---	---	---

SMD POWER BEAD SMB4B SERIES



FEATURES:

- Small size, high current, high performance.
- Low DCR, excellent EMI suppression capability.
- Suitable for surface mounting equipment.

COMMON APPLICATIONS:

- VTR, digital set-top box, LCD Monitor
- DC/DC converters, xDSL
- Wireless communication equipment

ELECTRICAL CHARACTERISTICS: 25°C

Part Number	Impedance 25MHz (Min)	Impedance 100MHz (Min)
SMB4B1155-141	140	255
SMB4B1111H-201	200	240
SMB4B1111H-2T-451	450	550
SMB4B1111H-3T-801	800	850
SMB4B1111L-121	125	210
SMB4B1111L-2T-281	280	450
SMB4B1111L-3T-551	550	800

PHYSICAL CHARACTERISTICS & TYPE

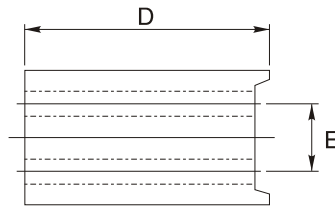
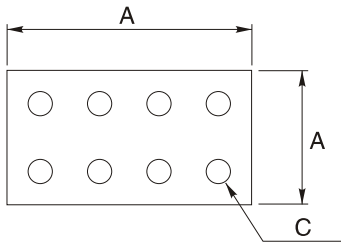

TYPE: SMB4B-2T

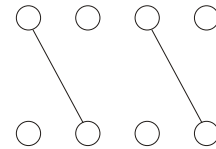

TYPE: SMB4B-3T

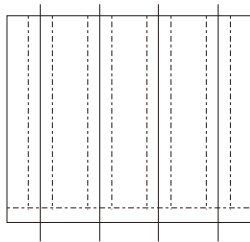
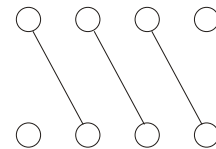

Part No.	A	B	C	D	E
SMB4B1155	11 ± 0.3	5.5 ± 0.25	0.65REF	10.5 ± 0.3	2.54REF
SMB4B1111H	11 ± 0.15	11 ± 0.2	0.7REF	10.5 ± 0.3	2.54REF
SMB4B1111L	11 ± 0.15	11 ± 0.2	0.7REF	6.5 ± 0.3	2.54REF

Note:

1. The parameters of list are typical, atypical parameters can be customized according to customer's requirements.
2. Operating temperature: -40°C to 105°C

SMD EMI SUPPRESSION 5-HOLE FERRITE BEAD

SMB5H SERIES



FEATURES:

- High Current rating
- Low DCR and high IDC beads inductor
- Compact and simple design with high reliability
- Very good SMD solution for traditional wide band choke
- Through-hole axial ferrite beads for EMI suppression
- Surface-mount wire wound beads with high frequency and EMI suppression

APPLCATIONS:

- Modems, PDP, LCD, and TVs converters
- Mobile radios, DC/DC converters
- Noise filtering devices
- Track and SCR control circuits
- Wireless communication equipments
- Computer disk drive and PC board to filter the EMI from outside sources such as car radios, mobile phones and VCRs

DIMENSIONS:(mm)

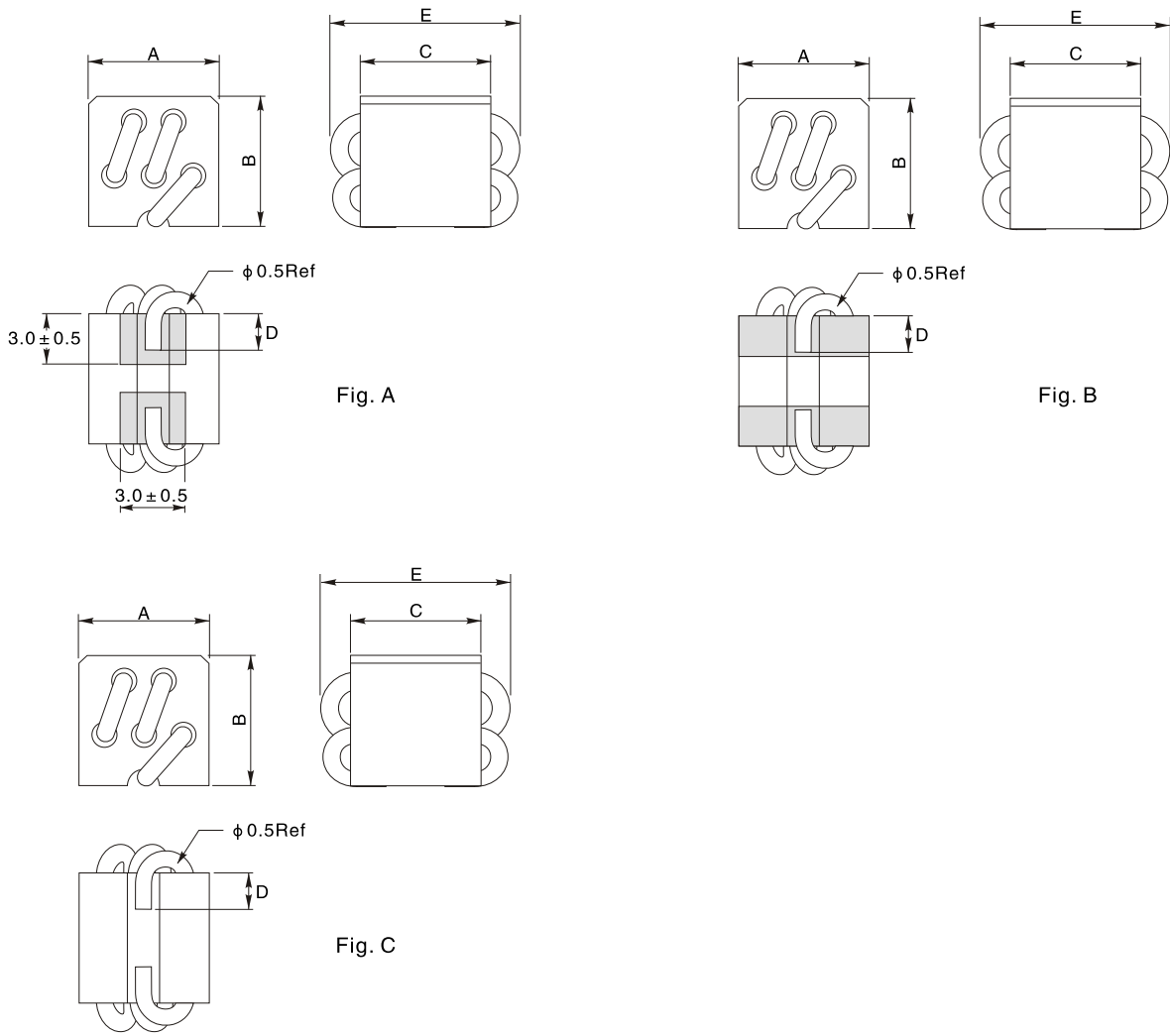

Part No.	A	B	C	D	E	Winding	Fig.
SMB5H0505C-2.5Ts	5.0 ± 0.25	5.0max	5.5 ± 0.3	2.0min	8.0max	φ 0.5mm*2.5Ts	C
SMB5H0505B-2.5Ts	5.0 ± 0.5	4.6 ± 0.5	5.5 ± 0.5	2.0max	8.0max	φ 0.5mm*2.5Ts	B
SMB5H0508C-2.5Ts	5.0 ± 0.25	5.0max	8.5 ± 0.3	3.5max	11.0max	φ 0.5mm*2.5Ts	C
SMB5H0508B-2.5Ts	5.0 ± 0.5	4.65 ± 0.5	8.5 ± 0.5	2.0 ± 0.5	11.0max	φ 0.5mm*2.5Ts	B
SMB5H0508A-2.5Ts	5.0 ± 0.5	4.65 ± 0.5	8.5 ± 0.5	2.0min	11.0max	φ 0.5mm*2.5Ts	A

SMD EMI SUPPRESSION 5-HOLE FERRITE BEAD

SMB5H SERIES

IMPEDANCE VS FREQUENCY CURVE

SMB5H0505C-2.5Ts

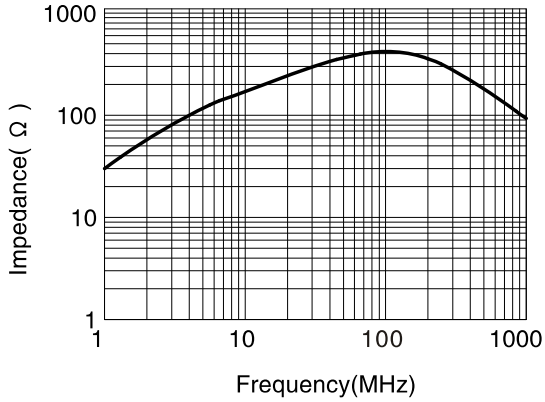

SMB5H0505B-2.5Ts

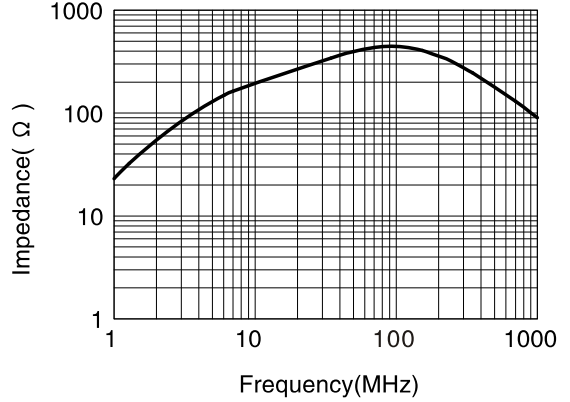

SMB5H0508C-2.5Ts

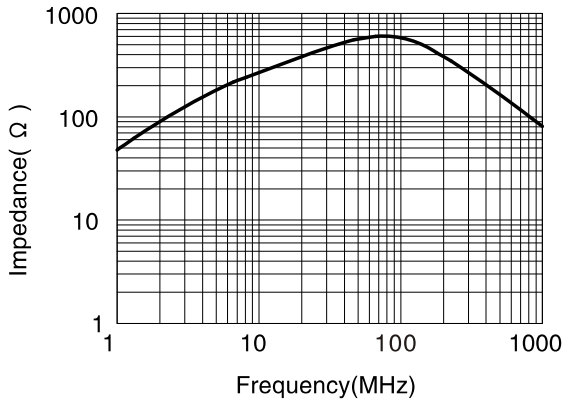

SMB5H0508B-2.5Ts

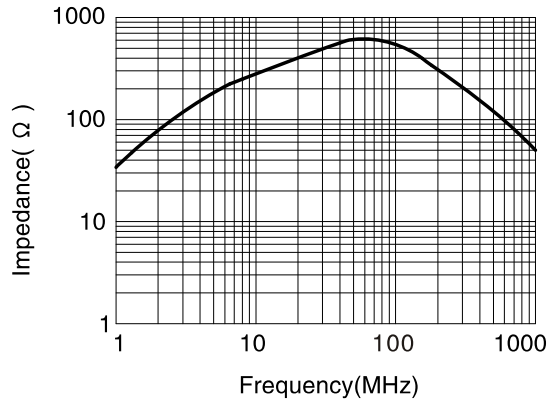

SMB5H0508A-2.5Ts

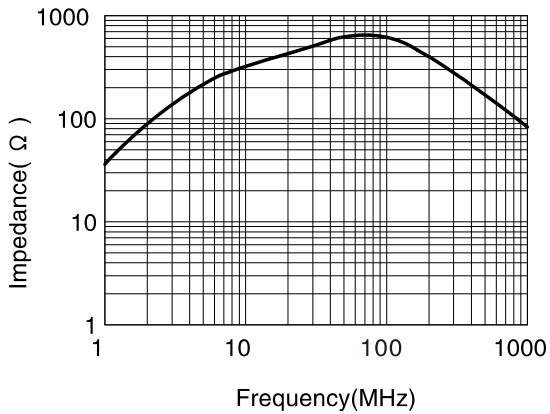

TOROIDAL CORE(T)

Ordering code

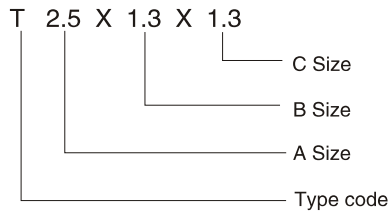

CONFIGURATIONS(mm)

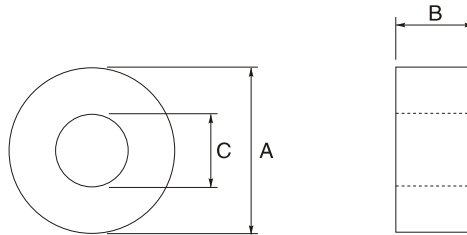

DIMENSION OF MAIN PRODUCTIONS & IMPEDANCE@25°C

Part No.	A	B	C	IMPEDANCE	
				25MHz(Ω)	100MHz(Ω)
T2.5X1.3X1.3	2.5±0.3	1.3±0.3	1.3±0.3	10	50
T3X3X1.2	3.0±0.3	3.0±0.3	1.2±0.3	20	65
T3.5X2X1.8	3.5±0.4	2.0±0.4	1.8±0.3	20	60
T3.5X3X1.0	3.5±0.4	3.0±0.4	1.0±0.3	30	75
T3.5X3X0.8	3.5±0.4	3.0±0.4	0.8±0.3	30	80
T3.5X3X1.8	3.5±0.4	3.0±0.4	1.8±0.3	20	65
T3.5X3.2X1.6	3.5±0.4	3.2±0.4	1.6±0.3	20	65
T4X1X2	4.0±0.4	1.0±0.3	2.0±0.3	15	60
T4X2X2	4.0±0.4	2.0±0.4	2.0±0.3	20	65
T4X3X2	4.0±0.4	3.0±0.4	2.0±0.3	20	65
T4X4X1.5	4.0±0.4	4.0±0.4	1.5±0.3	25	70
T4X4X2	4.0±0.4	4.0±0.4	2.0±0.3	20	70
T5X2.5X3	5.0±0.4	2.5±0.4	3.0±0.3	15	65
T5X4X3	5.0±0.4	4.0±0.4	3.0±0.3	20	65
T5X5X3	5.0±0.4	5.0±0.4	3.0±0.3	25	70
T6X2X3	6.0±0.4	2.0±0.3	3.0±0.3	15	60
T6X3X3	6.0±0.4	3.0±0.4	3.0±0.3	20	65
T6X3X4	6.0±0.4	3.0±0.4	4.0±0.4	15	60
T6X4X3	6.0±0.4	4.0±0.4	3.0±0.3	25	70
T6X4X4	6.0±0.4	4.0±0.4	4.0±0.4	20	65
T6X6X3	6.0±0.4	6.0±0.4	3.0±0.3	25	75
T6X6X4	6.0±0.4	6.0±0.4	4.0±0.4	20	65
T6.5X5X4	6.5±0.4	5.0±0.4	4.0±0.4	20	70
T6.5X5X4.3	6.5±0.4	5.0±0.4	4.3±0.4	20	65
T7X7X4	7.0±0.4	7.0±0.4	4.0±0.4	25	80

TOROIDAL CORE(T)**DIMENSION OF MAIN PRODUCTIONS & IMPEDANCE@25°C**

Part No.	A	B	C	IMPEDANCE	
				25MHz(Ω)	100MHz(Ω)
T7.6X2X5.3	7.6±0.4	2.0±0.4	5.3±0.4	15	60
T7.6X3.6X4.2	7.6±0.4	3.6±0.4	4.2±0.4	20	70
T7.6X5X5.2	7.6±0.4	5.0±0.4	5.2±0.4	20	65
T7.6X6X5	7.6±0.4	6.0±0.4	5.0±0.4	20	70
T8X2X4	8.0±0.3	2.0±0.4	4.0±0.4	15	60
T8X3X4	8.0±0.4	3.0±0.4	4.0±0.4	20	65
T8X4X4	8.0±0.4	4.0±0.4	4.0±0.4	25	70
T8X6.3X5.6	8.0±0.4	6.3±0.4	5.6±0.4	20	70
T8X7X6	8.0±0.4	7.0±0.4	6.0±0.4	20	65
T8X7.5X5.3	8.0±0.4	7.5±0.4	5.3±0.4	20	75
T8X8X4	8.0±0.4	8.0±0.4	4.0±0.4	35	90
T9X3X5	9.0±0.4	3.0±0.4	5.0±0.4	20	60
T9.1X4.6X5	9.1±0.4	4.6±0.4	5.0±0.4	20	70
T9X4.5X5	9.0±0.4	4.5±0.4	5.0±0.4	20	70
T9X8X5	9.0±0.3	8.0±0.3	5.0±0.3	30	80
T9.5X5X5	9.5±0.4	5.0±0.4	5.0±0.4	20	70
T9.5X9.5X5	9.5±0.4	9.5±0.4	5.0±0.4	35	90
T9.8X6.5X6	9.8±0.4	6.5±0.4	6.0±0.4	25	75
T10X2X6	10.0±0.4	2.0±0.4	6.0±0.4	15	60
T10X3X6	10.0±0.4	3.0±0.4	6.0±0.4	20	60
T10X4X6	10.0±0.4	4.0±0.4	6.0±0.4	20	65
T10X4X7	10.0±0.4	4.0±0.4	7.0±0.4	20	60
T10X5X5	10.0±0.4	5.0±0.4	5.0±0.4	25	75
T10X5X6	10.0±0.4	5.0±0.4	6.0±0.4	20	70
T10X6X6	10.0±0.5	6.0±0.5	6.0±0.5	25	75
T10X5X7	10.0±0.5	6.0±0.5	7.0±0.5	20	65
T10X7X6	10.0±0.4	7.0±0.4	6.0±0.4	25	75
T10X7.5X6	10.0±0.4	7.5±0.4	6.0±0.4	25	80
T10X7X7	10.0±0.4	7.0±0.4	7.0±0.4	20	70
T10X7.5X7	10.0±0.4	7.5±0.4	7.0±0.4	25	70
T10X8X6	10.0±0.4	8.0±0.4	6.0±0.4	30	80
T10X10X4.2	10.0±0.4	10.0±0.4	4.2±0.4	55	115
T10X10X5	10.0±0.4	10.0±0.4	5.0±0.4	35	85
T10X10X6	10.0±0.4	10.0±0.4	6.0±0.4	35	85
T10X10X7	10.0±0.5	10.0±0.4	7.0±0.4	30	80
T10.5X10X7.3	10.5±0.4	10.0±0.4	7.3±0.4	25	75
T10X20X4.2	10.0±0.4	20.0±0.6	4.2±0.6	100	200
T11X8X5	11.0±0.5	8.0±0.4	5.0±0.4	30	90
T12X4X6	12.0±0.5	4.0±0.4	6.0±0.4	25	70
T12X5X8	12.0±0.5	5.0±0.4	8.0±0.4	20	65
T12X5.3X7.3	12.0±0.5	5.3±0.4	7.3±0.4	20	75

TOROIDAL CORE(T)

DIMENSION OF MAIN PRODUCTIONS & IMPEDANCE@25°C

Part No.	A	B	C	IMPEDANCE	
				25MHz(Ω)	100MHz(Ω)
T12X5.5X7	12.0±0.5	5.5±0.4	7.0±0.4	20	70
T12X6X6	12.0±0.5	6.0±0.4	6.0±0.4	25	80
T12X6X7.3	12.0±0.5	6.0±0.4	7.3±0.4	25	70
T12X7X8	12.0±0.5	7.0±0.4	8.0±0.4	20	70
T12X8X6	12.0±0.5	8.0±0.4	6.0±0.4	35	85
T12X8X7	12.0±0.5	8.0±0.4	7.0±0.4	30	85
T12X9X5.6	12.0±0.5	9.0±0.4	5.6±0.4	40	105
T12X10X3.55	12.0±0.5	10.0±0.4	3.55±0.4	85	180
T12X10X7	12.0±0.5	10.0±0.4	7.0±0.4	35	85
T12X12X5.6	12.0±0.5	12.0±0.5	5.6±0.4	45	110
T12X12X6.5	12.0±0.5	12.0±0.5	6.5±0.4	40	95
T12X12X8	12.0±0.5	12.0±0.5	8.0±0.4	35	90
T12.5X6.5X5	12.5±0.5	6.5±0.4	5.0±0.4	35	85
T12.5X12X8	12.5±0.5	12.0±0.5	8.0±0.4	35	90
T12.7X6.35X7.9	12.7±0.5	6.35±0.3	7.9±0.4	25	70
T12.7X4.8X7.9	12.7±0.5	4.8±0.4	7.9±0.4	20	70
T12.7X9.6X7.9	12.7±0.5	9.6±0.4	7.9±0.4	30	90
T12.7X12.7X7.3	12.7±0.5	12.7±0.5	7.3±0.4	45	100
T12.7X12.7X7.9	12.7±0.5	12.7±0.5	7.9±0.4	40	95
T12.7X12.7X11	12.7±0.5	12.7±0.5	11.0±0.4	20	70
T13X3X7	13.0±0.5	3.0±0.4	7.0±0.4	20	65
T13X6.3X7	13.0±0.5	6.3±0.4	7.0±0.4	25	75
T13X6.5X8	13.0±0.5	6.3±0.4	8.0±0.4	20	70
T13X7X7	13.0±0.5	7.0±0.4	7.0±0.4	30	80
T13X10X8.2	13.0±0.5	10.0±0.4	8.2±0.5	30	85
T13X12.7X7.1	13.0±0.5	12.7±0.5	7.1±0.5	40	100
T14X4X8	14.0±0.5	4.0±0.4	8.0±0.4	20	70
T14X5X8	14.0±0.5	5.0±0.4	8.0±0.4	20	70
T14X5X9	14.0±0.5	5.0±0.4	9.0±0.4	20	70
T14X5.5X9	14.0±0.5	5.5±0.4	9.0±0.4	20	70
T14X14X10	14.0±0.5	14.0±0.5	10.0±0.4	35	90
T14.2X5X10	14.2±0.5	5.0±0.4	10.0±0.4	20	65
T14.2X5.5X8.7	14.2±0.5	5.5±0.4	8.7±0.4	20	70
T14.2X7X8	14.2±0.5	7.0±0.4	8.0±0.4	25	80
T14.2X8X9	14.2±0.5	8.0±0.4	9.0±0.4	25	75
T14.2X10X8	14.2±0.5	10.0±0.4	8.0±0.4	35	95
T14.2X8X10	14.2±0.5	8.0±0.6	10.0±0.6	20	70
T14.2X10.16X6.35	14.2±0.5	10.16±0.4	6.35±0.4	40	100
T14.2X12X7.8	14.2±0.5	12.0±0.4	7.8±0.4	45	105
T14.2X12.7X6.7	14.2±0.5	12.7±0.5	6.7±0.4	50	110
T14.2X13X8	14.2±0.5	13.0±0.5	8.0±0.4	45	110

TOROIDAL CORE(T)

DIMENSION OF MAIN PRODUCTIONS & IMPEDANCE@25°C

Part No.	A	B	C	IMPEDANCE	
				25MHz(Ω)	100MHz(Ω)
T14.2X13.8X6.35	14.2±0.5	13.8±0.5	6.35±0.4	50	130
T14.5X8X10	14.5±0.5	8.0±0.4	10.0±0.5	25	70
T15X5X10	15.0±0.5	5.0±0.4	10.0±0.5	20	65
T15X15X10.5	15.0±0.5	15.0±0.4	10.5±0.5	30	90
T15.2X12.5X10.5	15.2±0.5	12.5±0.4	10.5±0.5	30	85
T15.6X14X13.4	15.6±0.5	14.0±0.4	13.4±0.5	25	75
T15.87X14.3X7.9	15.87±0.5	14.3±0.4	7.9±0.4	55	125
T16X4X9	16.0±0.5	4.0±0.4	9.0±0.5	20	70
T16X4X10	16.0±0.5	4.0±0.4	10.0±0.5	20	65
T16X5X10	16.0±0.5	5.0±0.5	10.0±0.5	20	70
T16X5.4X9	16.0±0.5	5.4±0.5	9.0±0.5	20	70
T16X7X9	16.0±0.5	7.0±0.5	9.0±0.5	30	80
T16X7X10	16.0±0.5	7.0±0.4	10.0±0.5	25	75
T16X8X10	16.0±0.5	8.0±0.4	10.0±0.5	25	80
T16X8X12	16.0±0.5	8.0±0.4	12.0±0.5	20	70
T16X10X7	16.0±0.5	10.0±0.4	7.0±0.4	40	105
T16X10X8	16.0±0.5	10.0±0.4	8.0±0.4	45	105
T16X10X9	16.0±0.5	10.0±0.4	9.0±0.5	40	95
T16X10X10	16.0±0.5	10.0±0.4	10.0±0.5	30	85
T16X10X12	16.0±0.5	10.0±0.4	12.0±0.5	25	75
T16X12X9.5	16.0±0.5	12.0±0.5	9.5±0.5	30	90
T16X12X10	16.0±0.5	12.0±0.5	10.0±0.5	30	90
T16X13X8	16.0±0.5	13.0±0.5	8.0±0.4	45	115
T16X13X9	16.0±0.5	13.0±0.5	9.0±0.5	40	100
T16X14X10	16.0±0.5	14.0±0.5	10.0±0.5	40	100
T16X15X9	16.0±0.5	15.0±0.5	9.0±0.5	50	115
T16X16X8	16.0±0.5	16.0±0.5	8.0±0.4	65	130
T16X16X9	16.0±0.5	16.0±0.5	9.0±0.5	50	115
T16X16X10	16.0±0.5	16.0±0.5	10.0±0.5	50	110
T17.5X6.35X9.5	17.5±0.6	6.35±0.4	9.5±0.5	25	75
T17.5X7X9.6	17.5±0.6	7.0±0.4	9.6±0.5	30	85
T17.5X10X8	17.5±0.6	10.0±0.4	8.0±0.4	40	100
T17.5X11X9.5	17.5±0.6	11.0±0.5	9.5±0.5	40	90
T17.5X12X11.3	17.5±0.6	12.0±0.5	11.3±0.5	30	90
T17.5X12.5X12	17.5±0.6	12.5±0.5	12.0±0.5	30	90
T17.5X9.5X12.7	17.5±0.6	9.5±0.4	12.7±0.5	25	80
T17.5X12.7X9.5	17.5±0.6	12.7±0.5	9.5±0.5	45	110
T17.5X12.7X10.7	17.5±0.6	12.7±0.5	10.7±0.5	40	95
T17.5X13.5X9.5	17.5±0.6	13.5±0.5	9.5±0.5	50	110
T17.5X15X9.5	17.5±0.6	15.0±0.5	9.5±0.5	55	125
T18X6X10	18.0±0.6	6.0±0.5	10.0±0.5	25	75

TOROIDAL CORE(T)**DIMENSION OF MAIN PRODUCTIONS & IMPEDANCE@25°C**

Part No.	A	B	C	IMPEDANCE	
				25MHz(Ω)	100MHz(Ω)
T18X7X10	18.0±0.6	7.0±0.4	10.0±0.4	30	80
T18X8X10	18.0±0.6	8.0±0.4	10.0±0.5	30	85
T18X10X10	18.0±0.6	10.0±0.4	10.0±0.5	35	90
T18X12X10	18.0±0.6	12.0±0.5	10.0±0.5	45	105
T18X12X12	18.0±0.6	12.0±0.5	12.0±0.5	30	85
T18X14X10	18.0±0.6	14.0±0.5	10.0±0.5	50	110
T18X15X10	18.0±0.6	15.0±0.5	10.0±0.4	50	120
T18X18X10	18.0±0.6	18.0±0.6	10.0±0.5	70	130
T18.2X6.4X11.2	18.2±0.6	6.4±0.4	11.2±0.5	20	75
T18.2X6.5X10	18.2±0.6	6.5±0.4	10.0±0.5	25	80
T18.4X9.6X12.5	18.4±0.6	9.6±0.4	12.5±0.5	25	85
T18.2X12.5X9.5	18.2±0.6	12.5±0.5	9.5±0.5	50	110
T18.4X14.3X9.5	18.4±0.6	14.3±0.5	9.5±0.5	50	115
T19X11X13	19.0±0.6	11.0±0.5	13.0±0.5	30	80
T19.5X12.7X9.5	19.5±0.6	12.7±0.5	9.5±0.5	50	120
T20X5X10	20.0±0.6	5.0±0.4	10.0±0.5	25	75
T20X7X10	20.0±0.6	7.0±0.4	10.0±0.5	30	80
T20X8X10	20.0±0.6	8.0±0.4	10.0±0.5	35	90
T20X10X10	20.0±0.6	10.0±0.4	10.0±0.5	40	95
T20X15X10	20.0±0.6	15.0±0.5	10.0±0.5	65	135
T20.8X30X11.6	20.8±0.6	30.0±0.5	11.6±0.5	90	200
T21X13X12	21.0±0.6	13.0±0.5	12.0±0.5	35	95
T21X12X13.2	21.0±0.6	12.0±0.5	13.2±0.5	30	85
T21X6X12.7	21.0±0.6	6.0±0.4	12.7±0.5	20	75
T22X8X14	22.0±0.6	8.0±0.4	14.0±0.5	30	80
T22.5X6.4X13.8	22.5±0.6	6.4±0.4	13.8±0.5	25	75
T22.5X6.4X14.3	22.5±0.6	6.4±0.4	14.3±0.4	25	70
T22.5X8X13.8	22.5±0.6	8.0±0.4	13.8±0.5	30	80
T22.5X10X13.8	22.5±0.6	10.0±0.4	13.8±0.5	35	90
T22.5X9.5X13.5	22.5±0.6	9.5±0.4	13.5±0.5	30	85
T22.5X12.7X13.5	22.5±0.6	12.7±0.5	13.5±0.5	40	95
T23X10X18	23.0±0.6	10.0±0.4	18.0±0.5	20	70
T23.5X9.5X12.7	23.5±0.6	9.5±0.4	12.7±0.5	35	90
T24X14X11.4	24.0±0.6	14.0±0.5	11.4±0.5	50	120
T25X8X15	25.0±0.6	8.0±0.4	15.0±0.5	25	80
T25X10X15	25.0±0.6	10.0±0.4	15.0±0.5	30	85
T25X12X15	25.0±0.6	12.0±0.5	15.0±0.5	40	95
T25X15X13	25.0±0.6	15.0±0.5	13.0±0.5	55	125
T25X15X15	25.0±0.6	15.0±0.5	15.0±0.5	45	110
T26X8X16	26.0±0.6	8.0±0.4	16.0±0.5	25	80
T26X15X13	26.0±0.6	15.0±0.5	13.0±0.5	50	120

TOROIDAL CORE(T)

DIMENSION OF MAIN PRODUCTIONS & IMPEDANCE@25°C

Part No.	A	B	C	IMPEDANCE	
				25MHz(Ω)	100MHz(Ω)
T28X7.5X16	28.0±0.7	7.5±0.4	16.0±0.6	30	80
T28X8X18	28.0±0.7	8.0±0.4	18.0±0.6	25	80
T28X10X16	28.0±0.7	10.0±0.4	16.0±0.6	35	90
T28X10X18	28.0±0.7	10.0±0.4	18.0±0.6	30	85
T28X13X16	28.0±0.7	13.0±0.5	16.0±0.6	45	105
T28X20X16	28.0±0.7	20.0±0.5	16.0±0.6	50	135
T28.5X28.5X13.8	28.5±0.7	28.5±0.7	13.8±0.5	120	250
T28X28X16	28.0±0.7	28.0±0.7	16.0±0.6	85	200
T29X7.7X19	29.0±1	7.7±0.4	19.0±0.6	25	75
T29X10X19	29.0±1	10.0±0.4	19.0±0.6	30	90
T29X12X19	29.0±1	12.0±0.4	19.0±0.6	35	90
T29X13.8X19	29.0±1	13.8±0.5	19.0±0.6	45	95
T29X15X19	29.0±1	15.0±0.5	19.0±0.6	35	100
T31X5X19	31.0±1	5.0±0.4	19.0±0.6	20	70
T31X7X19	31.0±1	7.0±0.4	19.0±0.6	25	80
T31X8X19	31.0±1	8.0±0.4	19.0±0.6	25	80
T31X10X19	31.0±1	10.0±0.4	19.0±0.6	35	90
T31X12X18	31.0±1	12.0±0.5	18.0±0.6	35	105
T31X12X21	31.0±1	12.0±0.5	21.0±0.5	30	85
T31X13X19	31.0±1	13.0±0.5	19.0±0.6	40	100
T31X16X19	31.0±1	16.0±0.5	19.0±0.6	50	115
T31X18X19	31.0±1	18.0±0.5	19.0±0.6	50	125
T35X6X20.8	35.0±1	6.0±0.5	20.8±0.6	30	75
T35X12.6X20.8	35.0±1	12.6±0.5	20.8±0.6	50	100
T36X10X20	36.0±1	10.0±0.4	20.0±0.6	30	70
T36X12X25	36.0±1	12.0±0.5	25.0±0.6	30	90
T36X12.7X25	36.0±1	12.7±0.5	25.0±0.6	35	85
T36X13X23	36.0±1	13.0±0.5	23.0±0.6	35	95
T36X20X23	36.0±1	20.0±0.6	23.0±0.6	50	115
T36X23X15	36.0±1	23.0±0.6	15.0±0.6	100	210
T40.6X15X27.4	40.6±1.5	15.0±0.5	27.4±0.6	40	90

Remarks:Other sizes are available upon request if your needs not listed in the catalog

CLIP-ON CORE(TRCN)

Ordering code

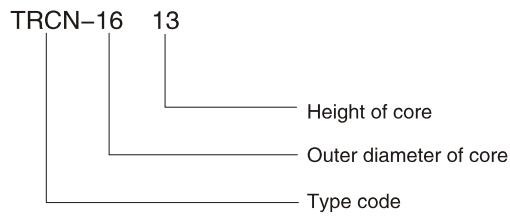

CONFIGURATIONS(mm)

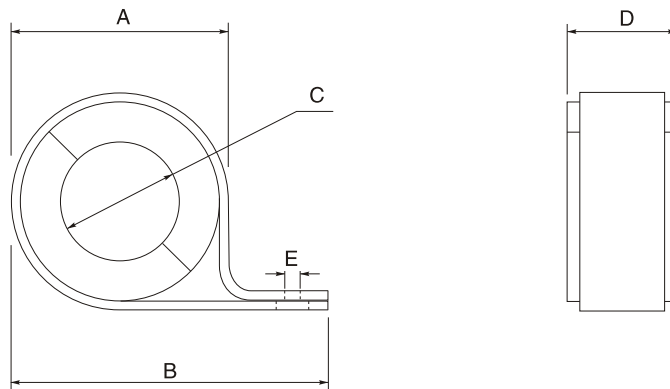

DIMENSION OF MAIN PRODUCTIONS & IMPEDANCE@25°C

Part No.	A	B	φ C	D	φ E	IMPEDANCE(1Ts)		IMPEDANCE(2Ts)	
						25MHz(Ω)	100MHz(Ω)	25MHz(Ω)	100MHz(Ω)
TRCN-1613	19.4	30.2	8	13.0	4.3	45	110	160	370
TRCN-1616	19.4	30.2	8	16.0	4.3	50	150	180	500
TRCN-2010	25.7	38.2	10	10.0	5.1	45	80	140	280
TRCN-2314	26.8	39.4	11.4	14.0	5.1	40	100	140	350
TRCN-2813	32.8	45.0	16.4	13.0	5.1	45	105	160	325
TRCN-2820	32.8	45.0	16.4	20.0	5.1	60	130	250	500
TRCN-4015	44.6	59.0	27.5	15.0	5.1	40	100	140	350

Remarks: Other sizes are available upon request if your needs not listed in the catalog