

铜箔变压器系列 Copper Foil Transformers Series

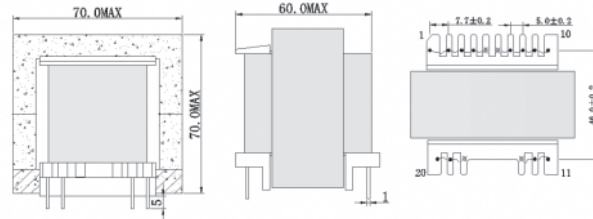

EE-65、EE-73、EE-85系列匝比: 15:5 17:5等



EE-65 EE-73 EE-85

铜箔变压器系列 Copper Foil Transformers Series



EE55系列匝比: 17:5 18:5等

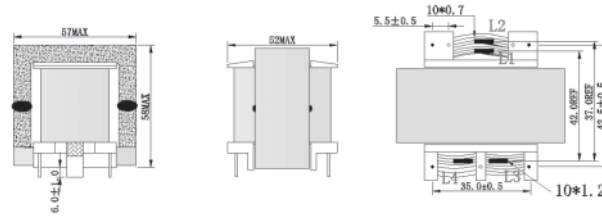

铜箔EE-55

铜箔变压器系列 Copper Foil Transformers Series



EE-55系列匝比: 17:5等

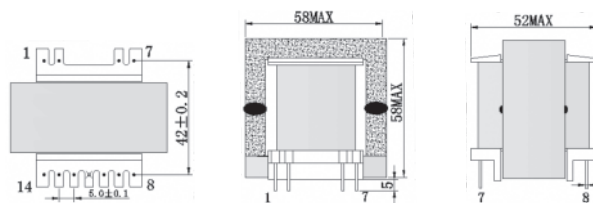

针式EE-55

铜箔变压器系列 Copper Foil Transformers Series



EER-43X15系列匝比: 9:4 10:4 10:5 10:9 12:4 13:4 13:5 20:4 22:3 21:4等

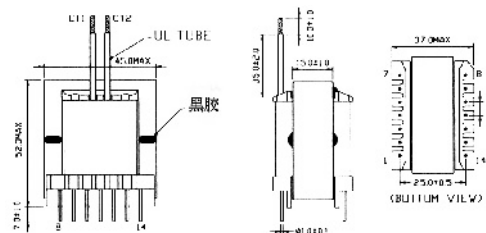

EE-43×15

丝包线变压器系列 Silk Covered Wire Transformers Series

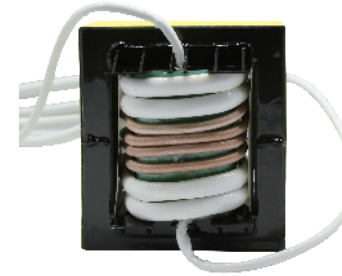

EE-110、EE-85系列匝比: 18:9 18:3 17:9 20:2 23:3 24:2 16:2

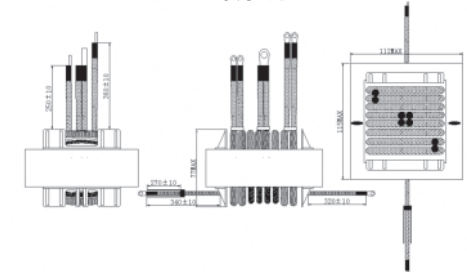

EE-110 EE-85

丝包线变压器系列 Silk Covered Wire Transformers Series



EE-85、EE-73系列匝比: 24:2 10:2 18:3 24:2

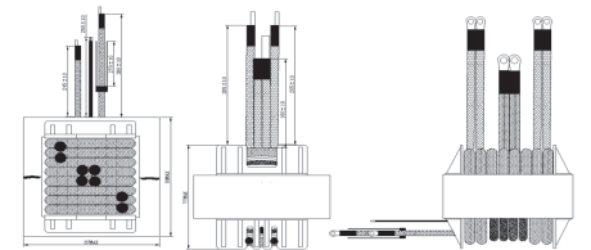

EE-85 EE-73

丝包线变压器系列 Silk Covered Wire Transformers Series

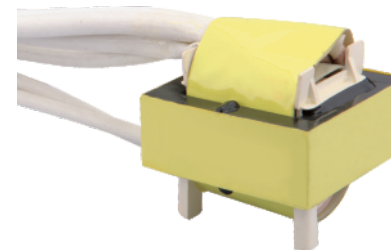

EE-65、EE-55系列匝比: 7:3 6:3 13:3 17:3

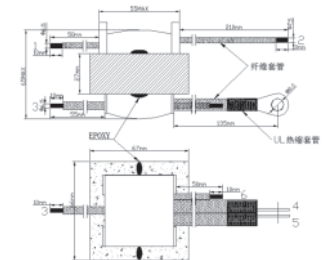

EE-65 EE-55

丝包线变压器系列 Silk Covered Wire Transformers Series

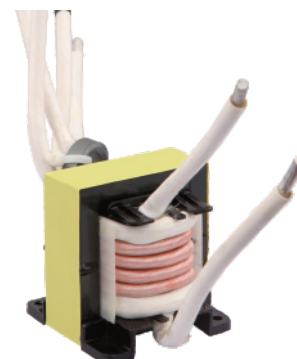

EE-65、EE-55系列匝比: 7:3 6:3 15:3 17:3

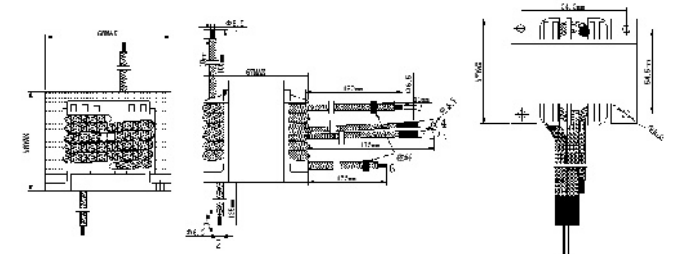

EE-65 EE-55

非晶变压器系列 Amorphous Transformers Series



丝包线 非晶 T100X60X20

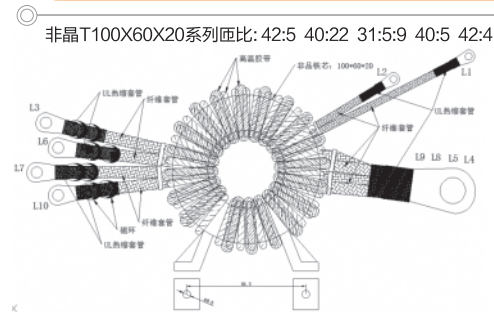

非晶变压器系列 Amorphous Transformers Series



多股线 非晶 T 100X60X20

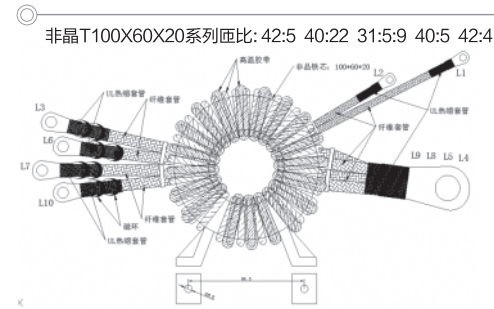

非晶变压器系列 Amorphous Transformers Series



非晶 T105X60X30

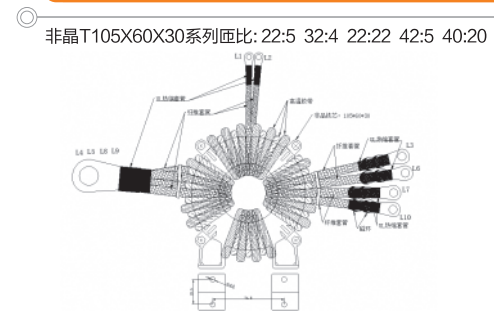

非晶变压器系列 Amorphous Transformers Series

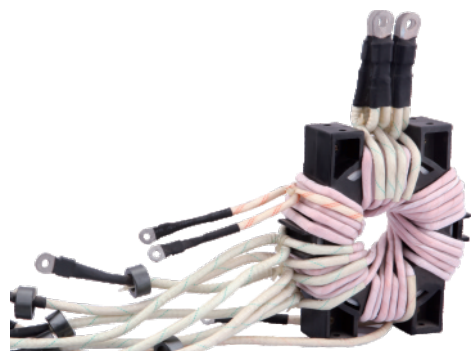

非晶 T130X80X40

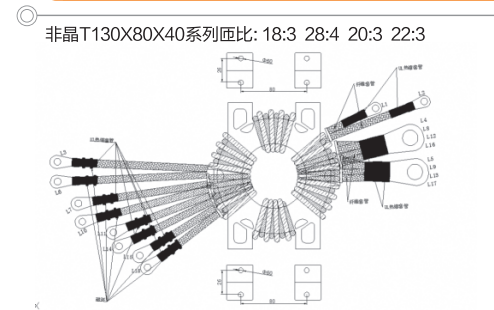

非晶变压器系列 Amorphous Transformers Series



非晶 T80X50X25 T70X40X25 T64X40X20

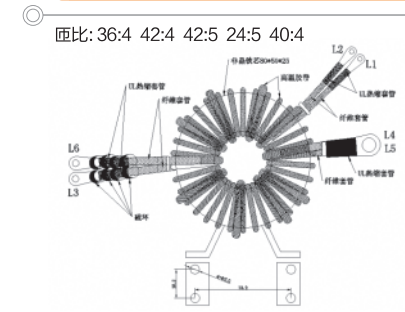

非晶变压器系列 Amorphous Transformers Series



非晶 T120X60X30 T120X70X20 T120X70X25

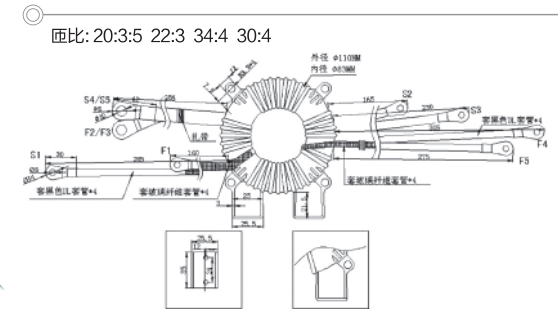

非晶变压器系列 Amorphous Transformers Series



非晶 T50X32X20 T64X40X20
T55X37X30 T40X25X20

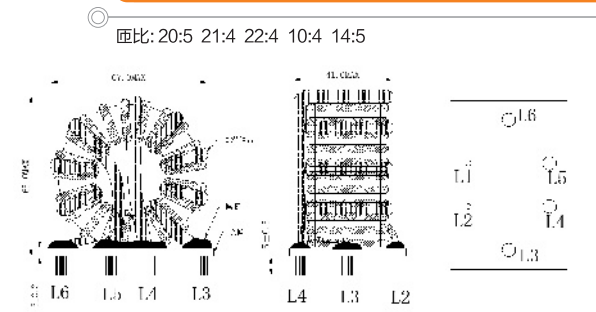

非晶变压器系列 Amorphous Transformers Series



铁氧体 T56X28X28 T63X38X25 T63X35X30

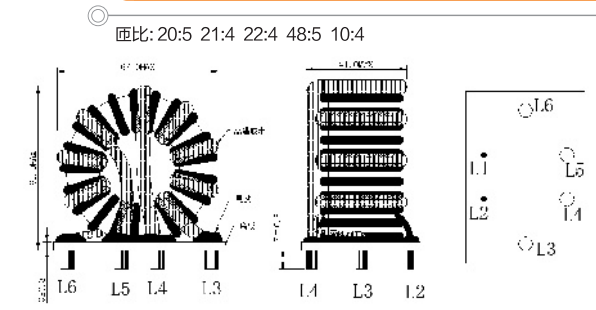

逆变变压器系列 Inverse Transformers Series

ETD-49系列匝比: 8:4 9:3 9:4 9:9 10:5 11:4 11:5
 13:4 20:4 22:3 22:4 28:5等



ETD-49

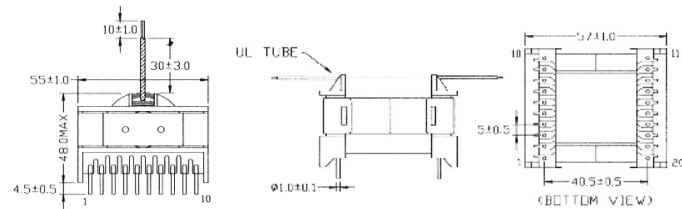

逆变变压器系列 Inverse Transformers Series

ETD-49系列匝比: 8:4 9:3 9:4 9:9 10:5 11:4 11:5 13:4 20:4
 22:3 22:4 28:5等

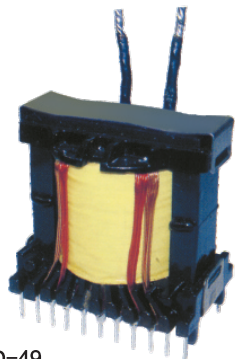

ETD-49

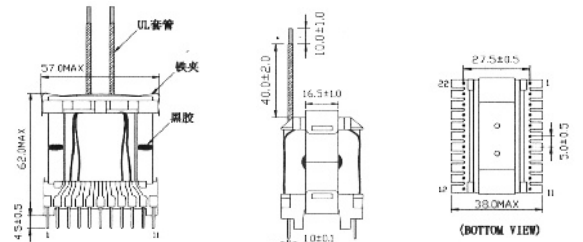

逆变变压器系列 Inverse Transformers Series

EE-65系列匝比: 15:5 16:5等

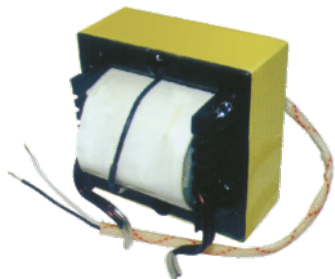

EE-65

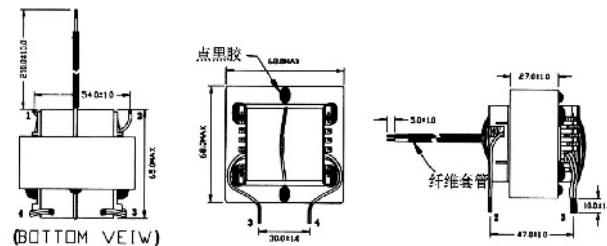

逆变变压器系列 Inverse Transformers Series

EE-70系列匝比: 15:5 16:5等

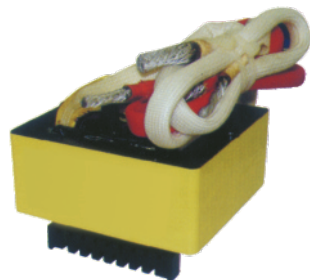

EE-70

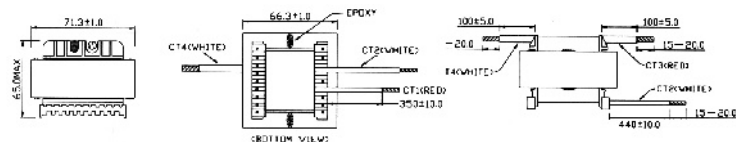

逆变变压器系列 Inverse Transformers Series

EE-85系列匝比: 15:5 16:5等

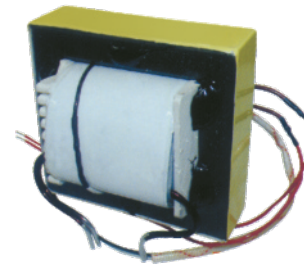

EE-85

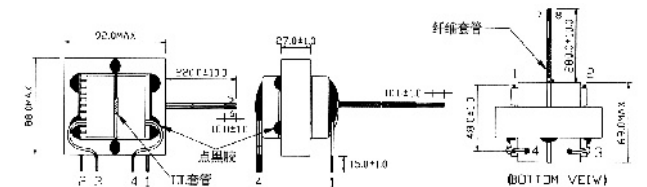

逆变变压器系列 Inverse Transformers Series

EER-43X15系列匝比: 10:9 22:10 23:11 24:9等

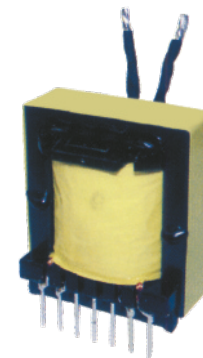

EER-43X15

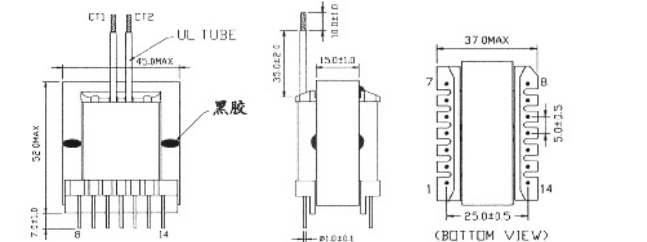

逆变变压器系列 Inverse Transformers Series

EER-43X15系列匝比: 9:4 10:4 10:5 10:9 12:4 13:4
 13:5 15:4 20:4 22:3 22:4 22:9 24:9 25:15等

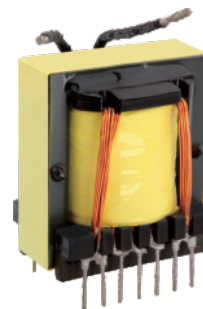

EER-43X15

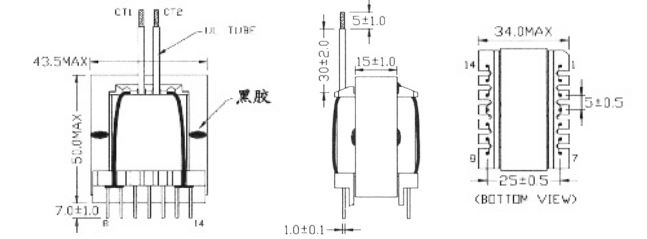

升压变压器系列 Step-up Transformers Series

ERL-35系列匝比: 43:100 43:127 43:130 43:160
 47:100 52:100 55:100 75:160等



ERL-35

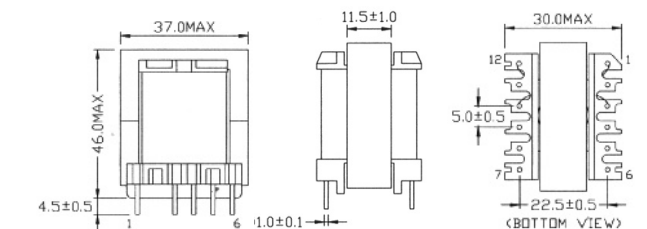

电抗器系列 Electric Reactors Serie

EI-96X40系列匝比: 8TS等

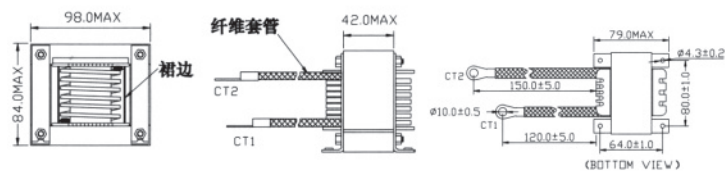

EI-96X40

电抗器系列 Electric Reactors Serie

EI-96系列匝比: 8.5TS 9.5TS等

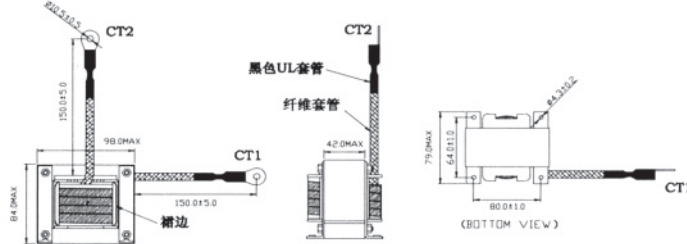

EI-96X40

电抗器系列 Electric Reactors Serie

EI-96系列匝比: 8.5TS 9.5TS等

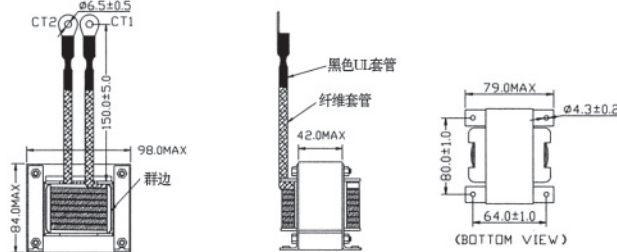

EI-96X40

电抗器系列 Electric Reactors Serie

EI-96系列匝比: 8.5TS 9.5TS等

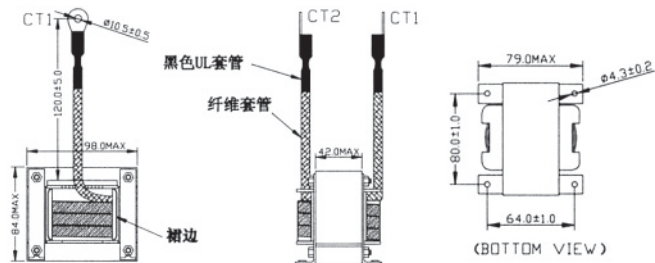

EI-96

电抗器系列 Electric Reactors Serie



铁氧体56-28-28

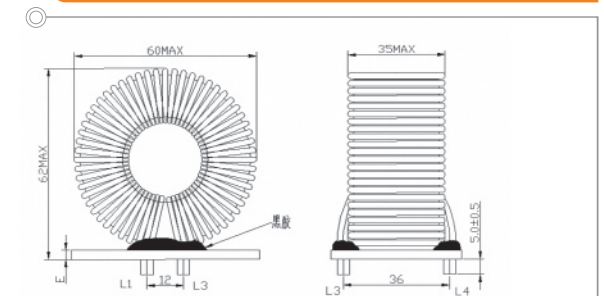

电抗器系列 Electric Reactors Serie

T184系列匝比: 22:22 28:28 30:30等

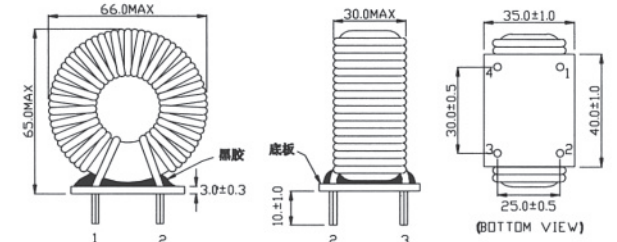

T184

电抗器系列 Electric Reactors Serie

T184系列匝比: 15:15 22:22 28:28 30:30等

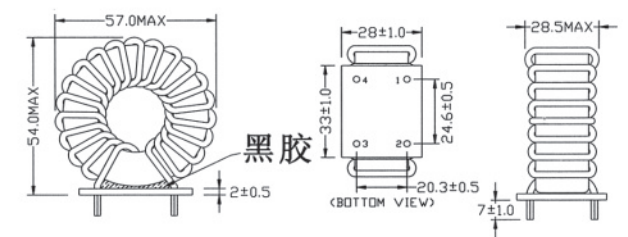

T184

电抗器系列 Electric Reactors Serie

T250-26系列匝比: 9:9:9:9等

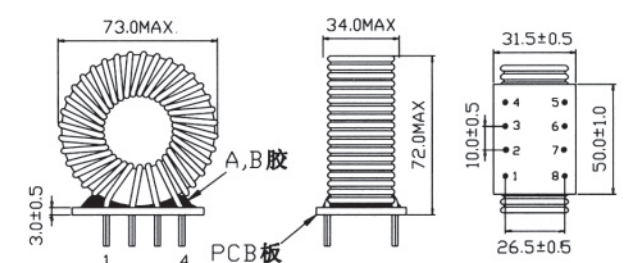

T250-26

